

APPENDIX 1

CIMA RECOMMENDED TREATMENTS

Recommended Potential Solutions

Hamilton Pipeline Trail Master Plan

May 1, 2015



Typical Uncontrolled Crossings



Typical Design for Uncontrolled Crossings

Curb Extensions or Optical Speed Table (photo below)



Recommendations:

- + Curb extensions could be utilized where width is available
- + Provide adequate sight lines for motorists and pedestrians in accordance with Provincial Design Standards
- + Assess illumination requirements for night-time visibility
- + Include signage for bicyclists to dismount when crossing
- + Consider pedestrian safety where alleys cross trail

OTM Book 15 Uncontrolled Crossing (pedestrians)

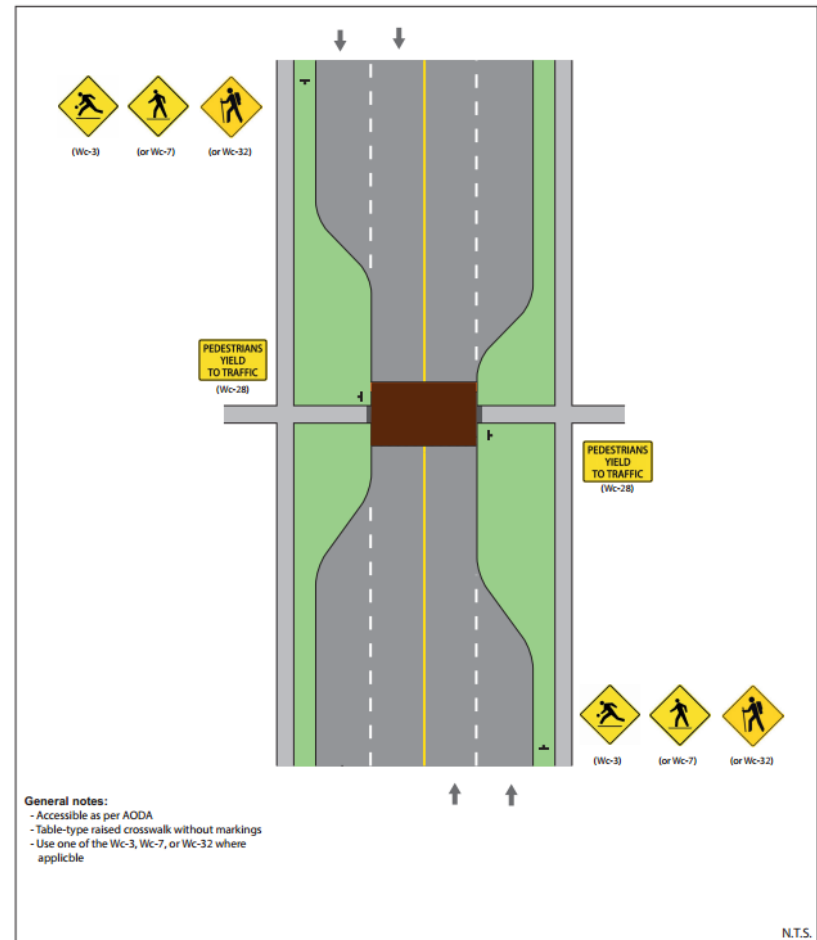
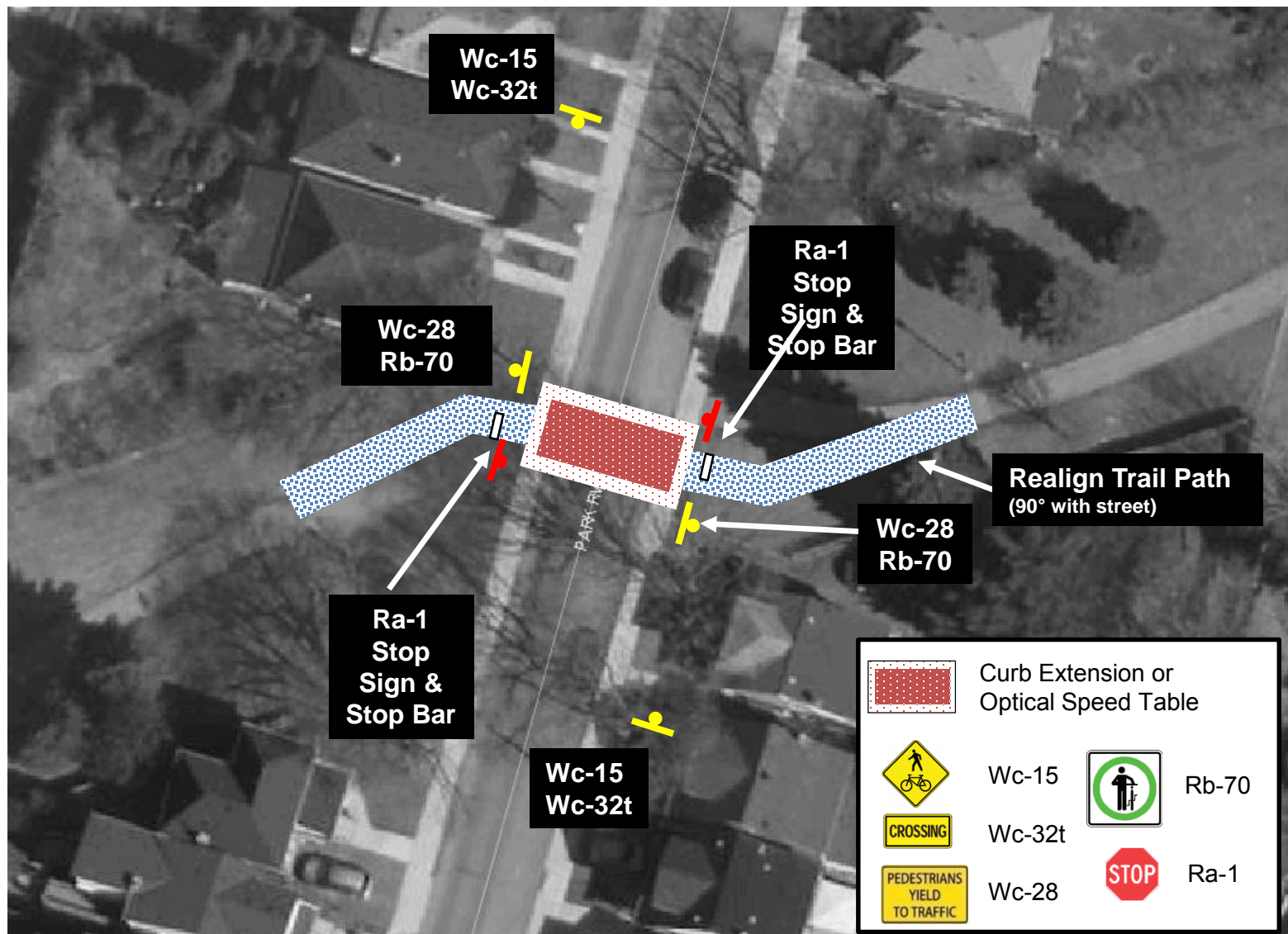

Figure 54: Typical Uncontrolled Pedestrian Crossing with Raised Crosswalk

Typical Uncontrolled Street Crossing



Approximate Loss of On-Street Parking / Design Details

| Location | Parking Reduction | Required Realignment | Notes |
|-------------------|--|----------------------|---|
| London Street N | None | None | Relocate illumination pole (west side) |
| Edgemont Street N | 4 west side [†] 3 east side [†] | Major | Requires encroachment onto private property |
| Park Row N | 3 east side | Minor | |
| Graham Avenue N | 4 west side | Minor | |
| Houghton Avenue N | 3 west side [†] 2 east side [†] | Moderate | May require use of parking area of #93 to realign path |
| Wexford Avenue N | 2 west side [†] 2 east side [†] | Moderate | May require use of parking area of #105 and/or #88(?) to realign path |
| Tragina Avenue N | None | None | |
| Weir Street N | None | Minor | |
| Fairfield Avenue | 3-4 east side | Minor | Close off south path on west side |
| Paling Avenue | 2 west side [†] 1 east side [†] | Minor | Close off south path on west side |

[†]These locations require only “partial” parking reduction due to parking being restricted only during certain periods of the year and/or month



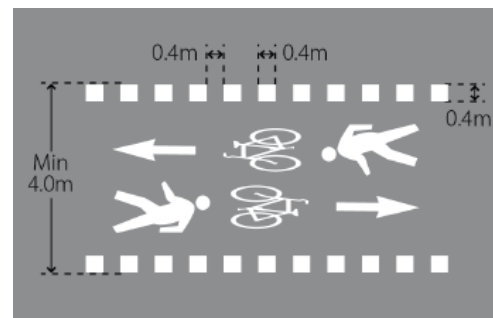
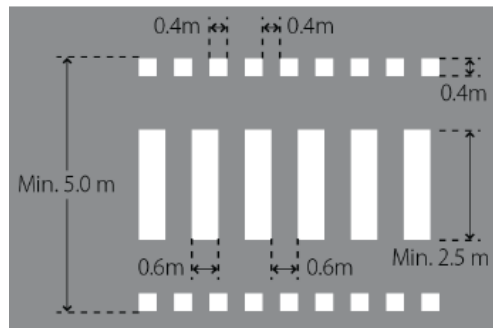
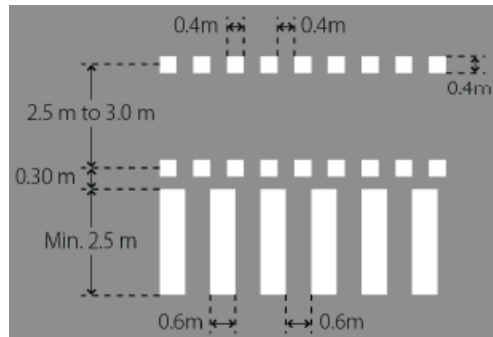

Source: OTM Book 18

Separate Crossride

- + Provides separate space for cyclists and pedestrians, the separate crossride design is generally applied where pedestrians and cyclists are segregated into exclusive facilities on the approach.

Combined Crossride

- + This design provides a combination with cyclists crossing on either side of pedestrians. This design may be more appropriate at midblock locations, due to the fact that it might funnel cyclists onto the sidewalk.

Mixed Crossride

- + Design suitable for locations with low volume crossings, particularly at unsignalized locations where motorists do not anticipate queueing of pedestrians or cyclists.

Dunsmure Rd & Province Ave + Mead Ave & Knox Ave

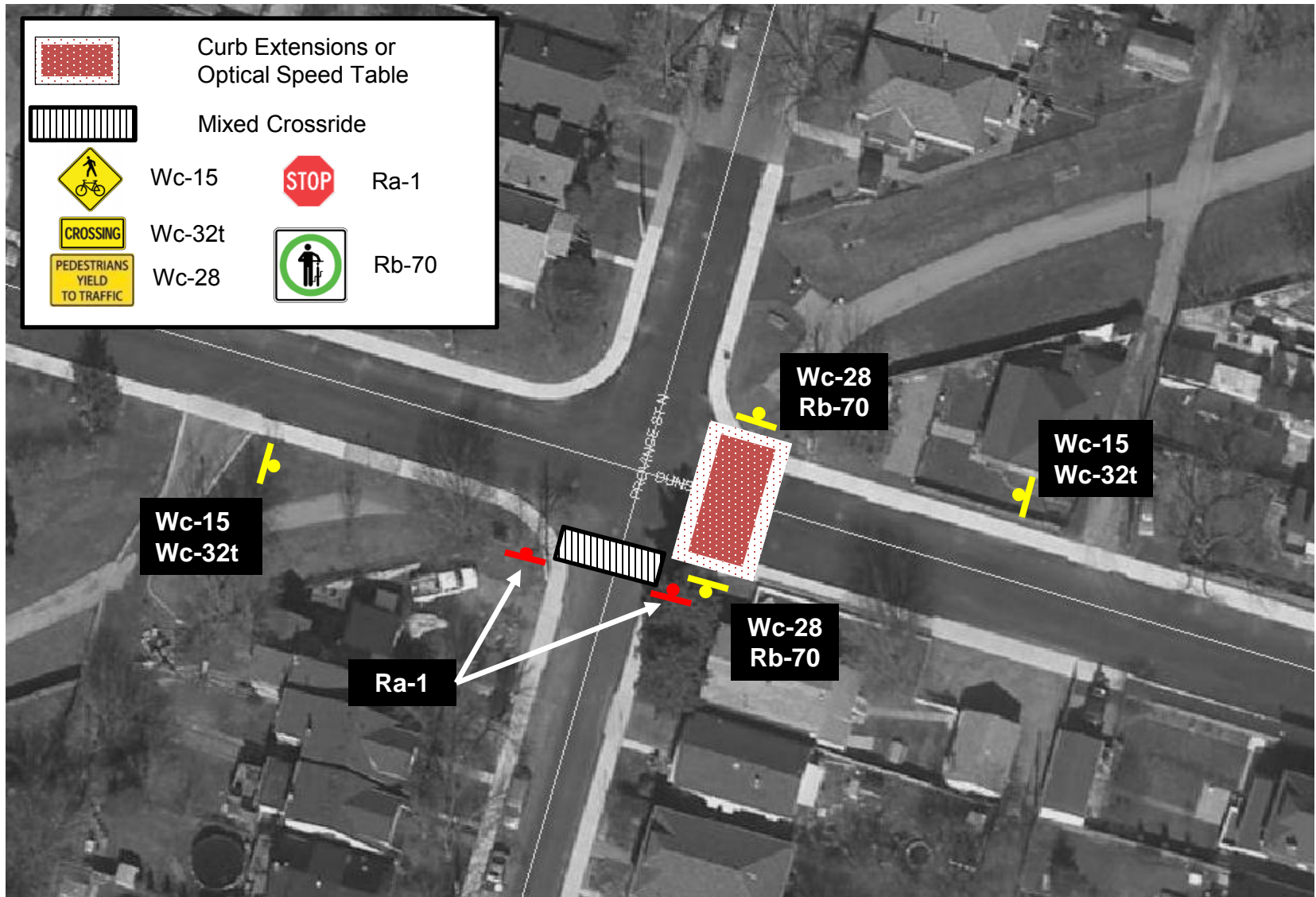

Dunsmure Rd & Province Ave + Mead Ave & Knox Ave

Consider PXO if volumes warrant (OTM Book 15)

PXO 'C'

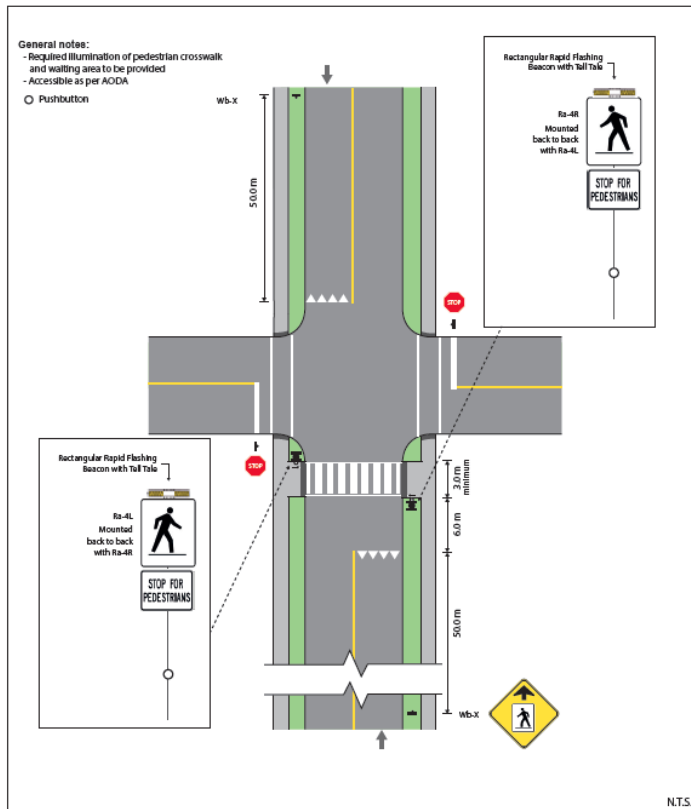

Figure 37: Pedestrian Crossover Type C – Intersection (2-way)

PXO 'D'

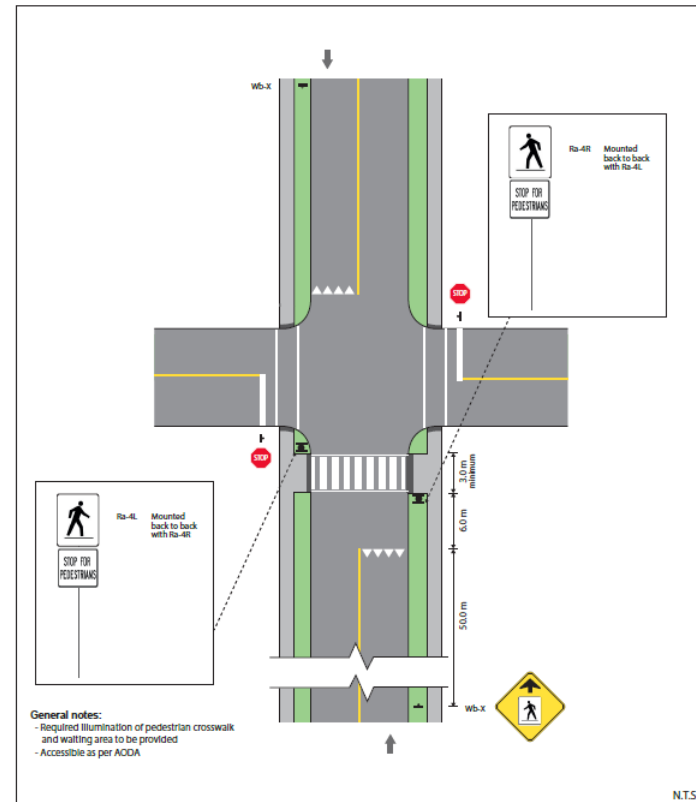

Figure 45: Pedestrian Crossover Type D – Intersection (2-way)

Kenilworth Avenue Area

Kenilworth Avenue Area
Detailed site plan showing property boundaries, lot numbers, and street layouts. The plan includes numerous small rectangular lots arranged in a grid-like pattern, with some larger irregular lots interspersed. The text is small and dense, typical of a technical drawing or map.

Kenilworth Avenue Area
Detailed site plan showing property boundaries, lot numbers, and street layouts. The plan includes numerous small rectangular lots arranged in a grid-like pattern, with some larger irregular lots interspersed. The text is small and dense, typical of a technical drawing or map.

Roxborough Ave & Huxley Ave to Crosthwaite Ave

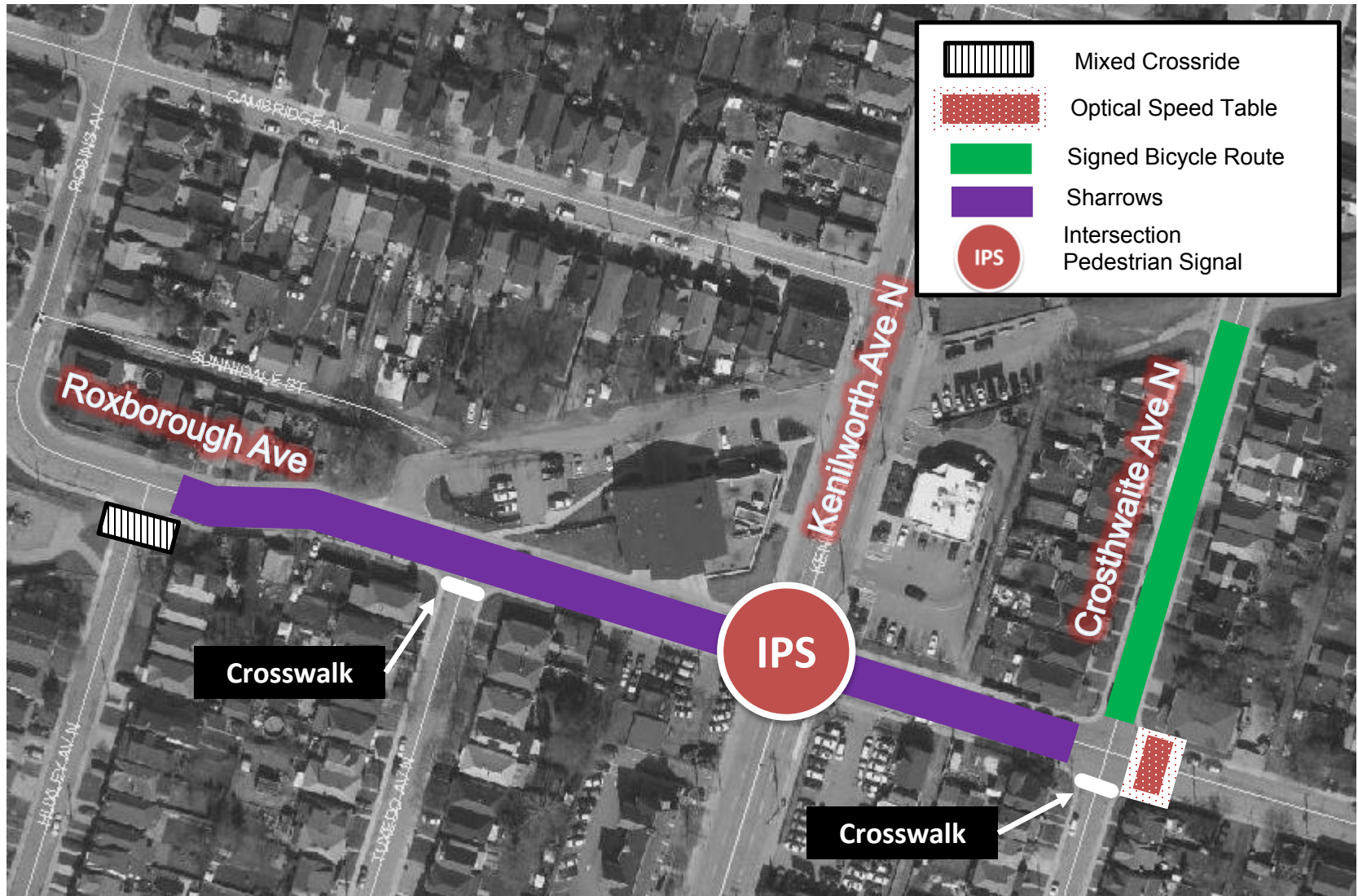

Roxborough Ave & Huxley Ave to Crosthwaite Ave

Kenilworth Ave IPS

OTM Book 15

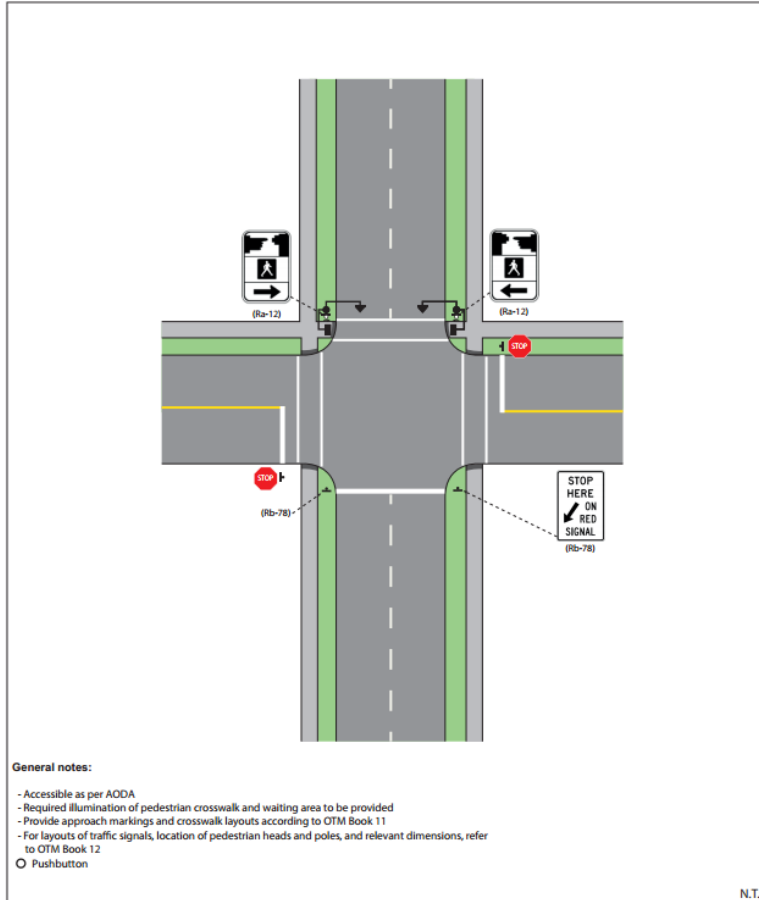

Figure 17: Intersection Pedestrian Signal Pedestrian Crossing Treatment (2-lane, 1-way)

- + Full Signal not warranted based on 2011 count
- + IPS potentially warranted based on 2011 count
- + New count and pedestrian delay study should be conducted to properly calculate warrants following OTM Book 12 and Book 15 procedures
- + Bicyclists cross Kenilworth Ave as a vehicle, obeying the Stop sign, or dismounting and using the IPS (provide signage)
- + Consider bicycle push buttons if volumes high; otherwise bikes follow rules of the road
- + Consider restricting on-street parking on Roxborough between Huxley and Tuxedo (approximately 10-12 spaces; can be relocated to side streets)

Roxborough Ave & Huxley Ave to Crosthwaite Ave

Sharrows (OTM Book 18)

Figure 2.3 – Shared Roadway with Sharrows



Signed Bicycle Route (OTM Book 18)



Bicycle Route Marker Sign

M511 (OTM)
(450 mm x 450 mm)

Cannon Street

Small, illegible text arranged in a large, abstract shape on the left side of the page.

Small, illegible text arranged in a large, abstract shape on the right side of the page.

Cannon St E from Garside Ave to Barons Ave

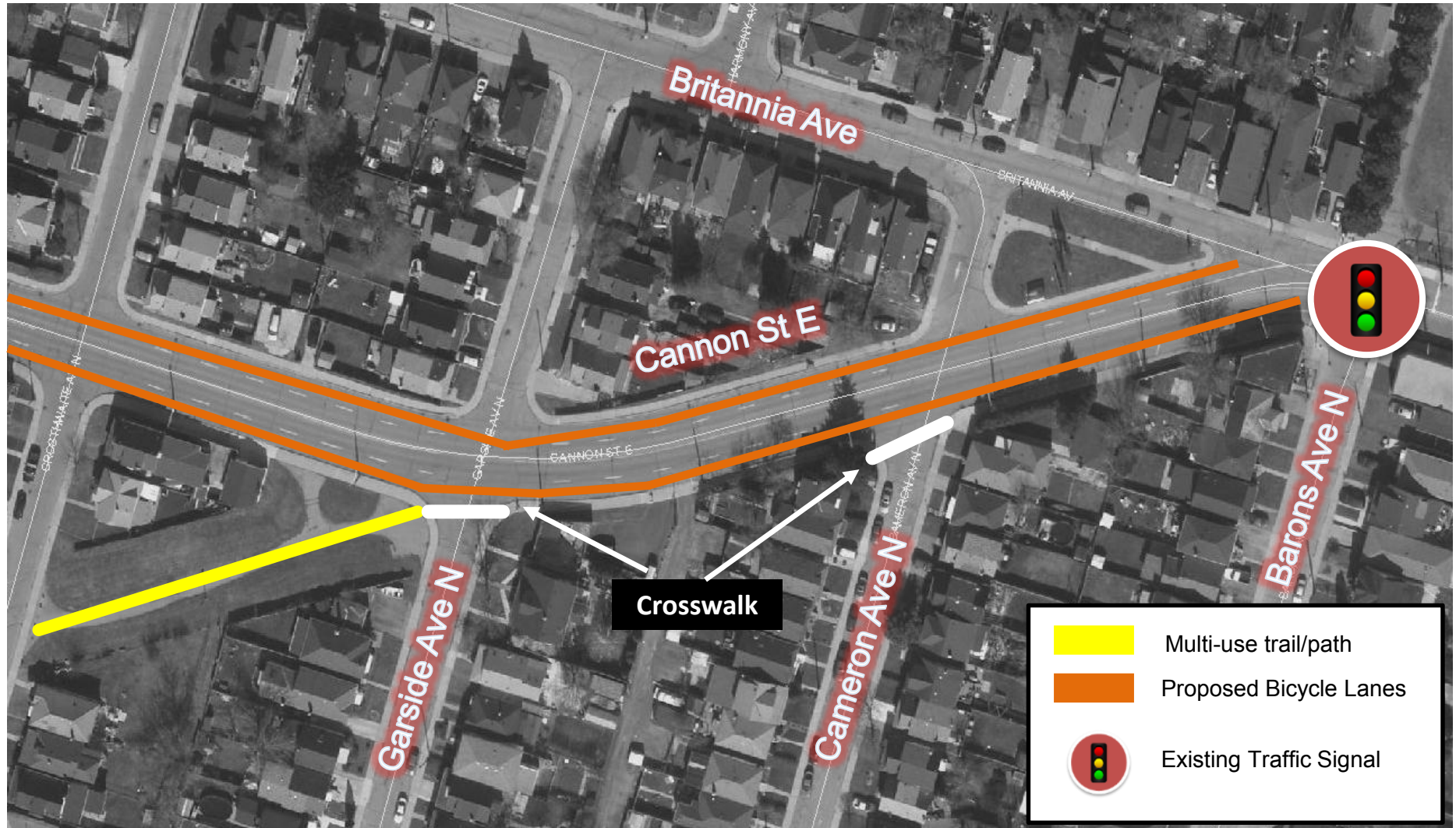

Barton Street, Parkdale Avenue & Woodward Ave – Short Term Solutions



Strathearne Ave to Barton St - Short Term

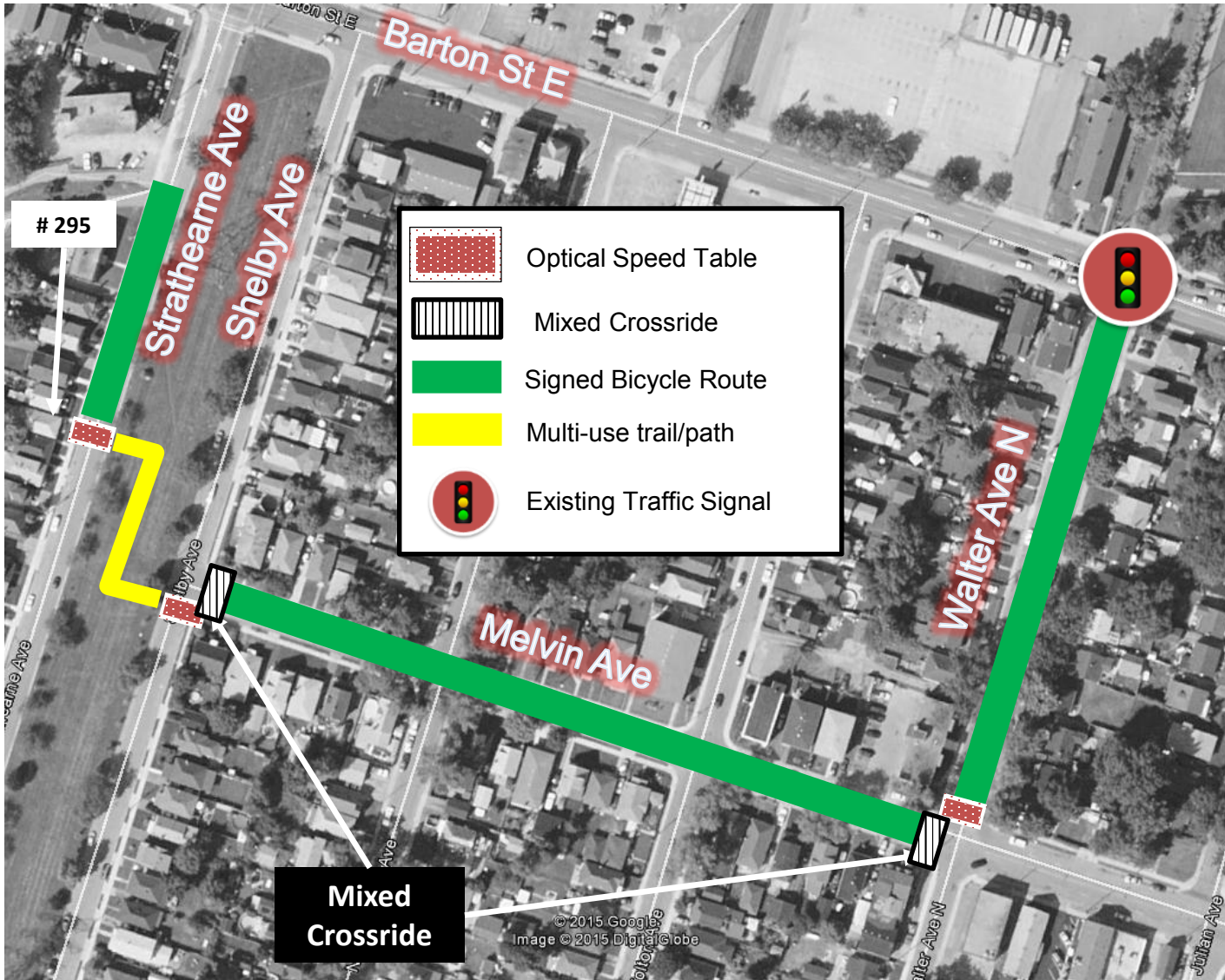

- + No reduction in parking availability expected
- + Provide wayfinding signage for pedestrians



Source: www.seareach.com

Barton St to Parkdale Ave – Short Term

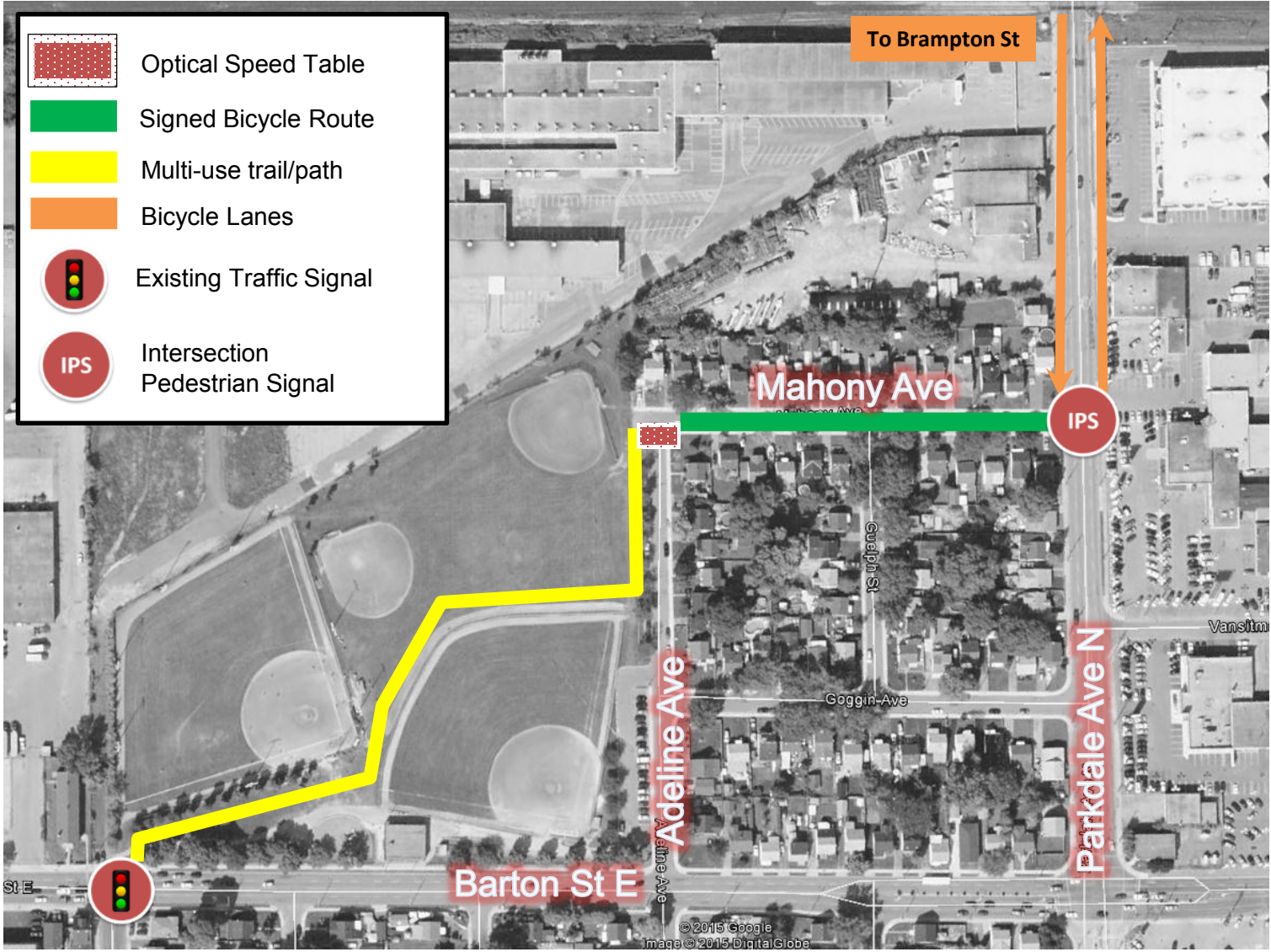

Barton St to Parkdale Ave – Short Term

Parkdale Ave IPS

- + PXO not recommended on 4-lane roads over 7,500 8-hour vehicular volumes (2008 7-hour count: 9,500+)
- + Consider IPS (pending new count and pedestrian delay study)

Railway Crossing

- + Provide pedestrian gates at railway



Source: www.ite.org

Parkdale Ave Bicycle Lanes



Source: bikesandtransit.wordpress.com

- + Short term: assess operations (volume to capacity ratio) during different periods of the day with and without bicycle lanes
- + Long term: consider widening the road or following the pipeline (negotiate with Orlik Industries, currently using the pipeline's ROW as an internal road)

Brampton St – Short Term



Tate Ave & Glow Ave – Short Term



Woodward Ave – Short Term

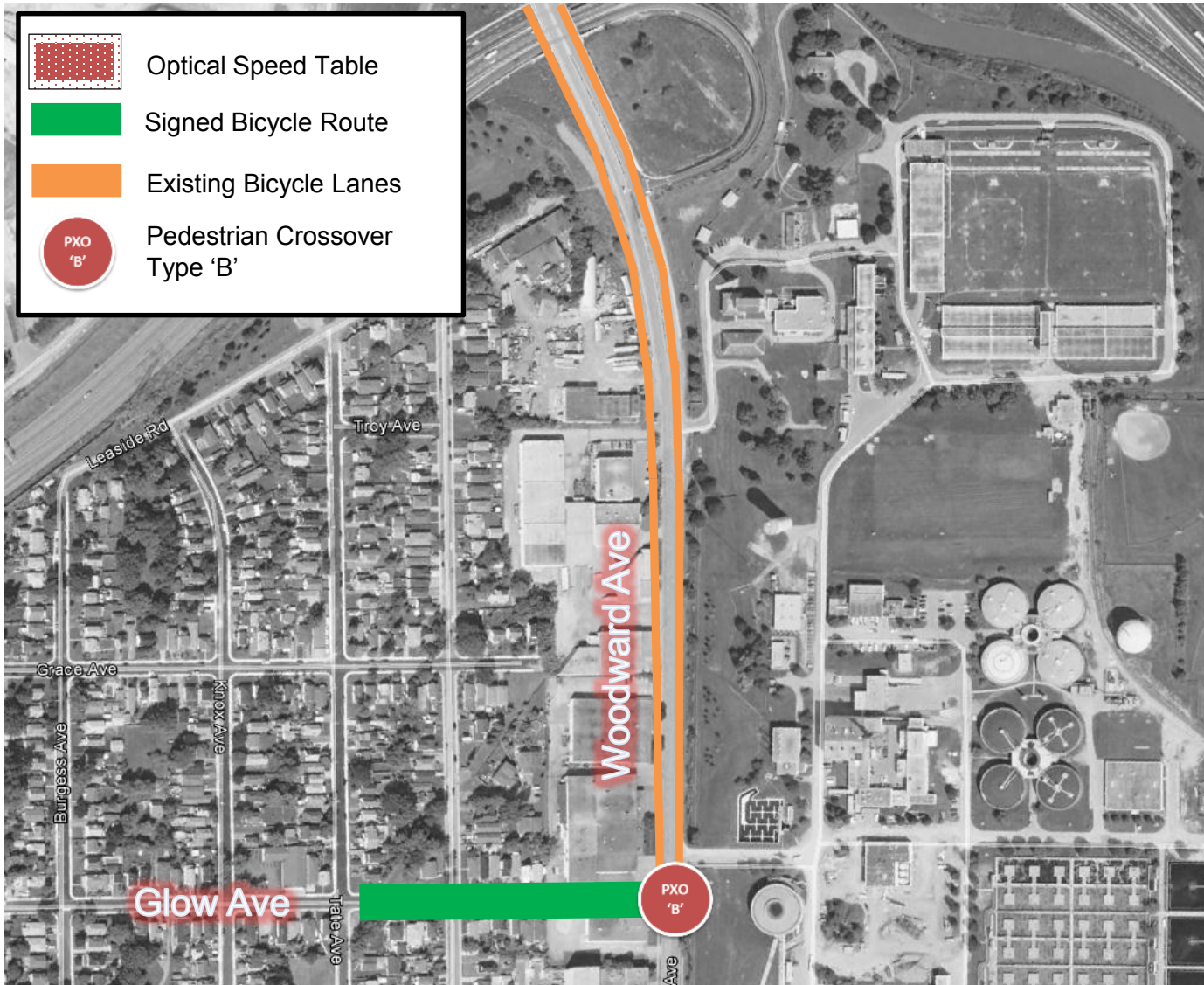

- + Woodward Avenue speed limit: 60 km/h
- + PXO Type 'B' located away from the curve to provide adequate visibility
- + New counts required to confirm volumes and warrant in accordance with OTM Book 15

Strathearne Ave to Barton St – Long Term



- + Multi-use pathway could be constructed with property from commercial areas on north side of Barton Street.
- + Special attention to driveways would be required to ensure safety of bicycles and pedestrians
- + Access to area along east side of Coca-Cola plant would need agreement.
- + Crossside could be implemented at traffic signal.

Barton St to Parkdale Ave – Long Term

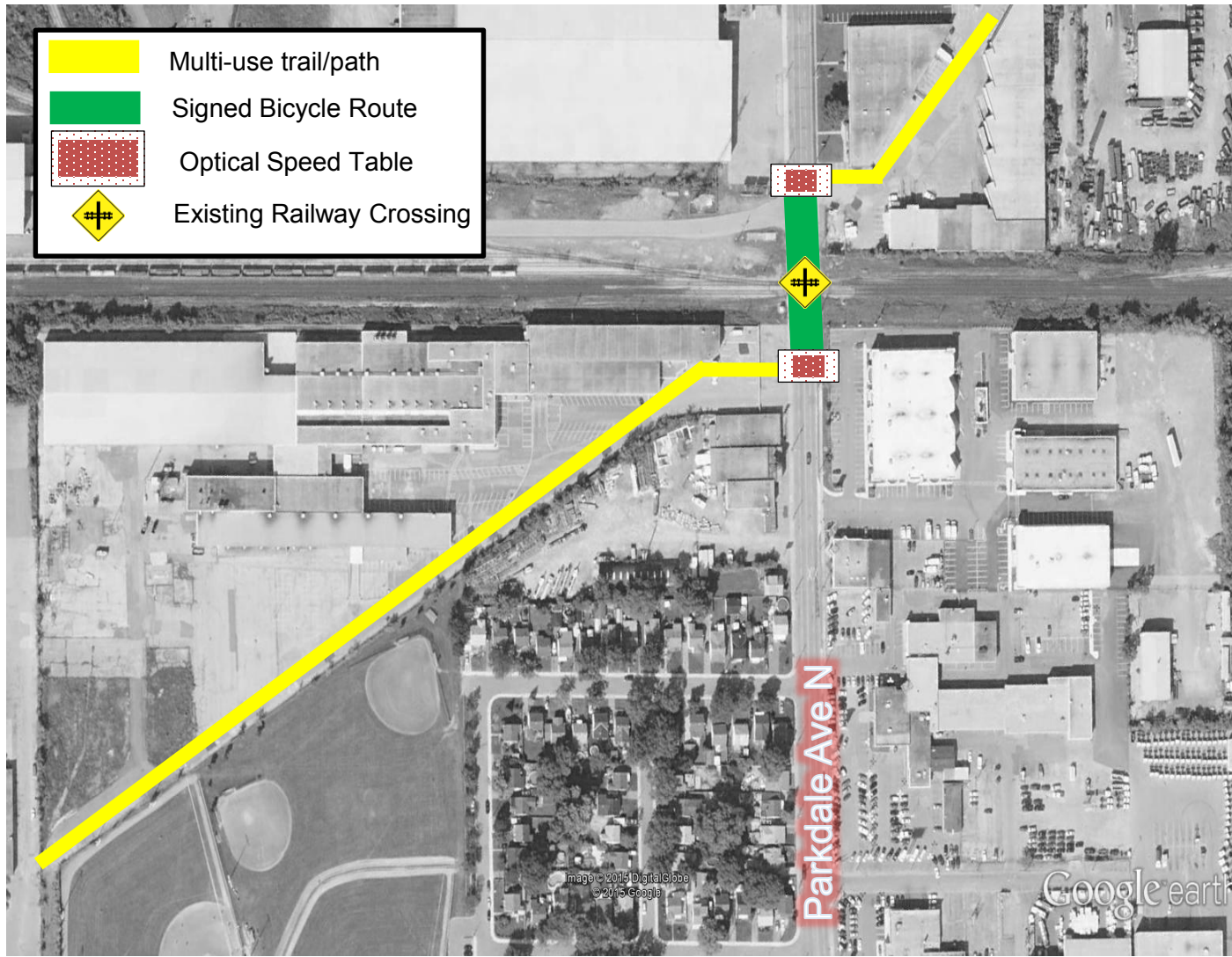

- + Trail runs approximately 500 metres through industrial property
- + Pedestrians and cyclists required to cross Parkdale Ave N along with an existing railway crossing to continue along the trail
- + Recommended installation of an optical speed table for pedestrians and cyclists to cross roadway to the north and south of railway crossing

Barton St to Parkdale Ave – Long Term

(a) Two Way

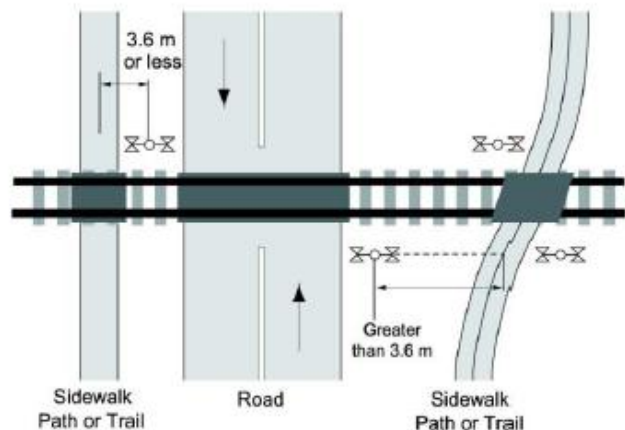

(b) One-Way

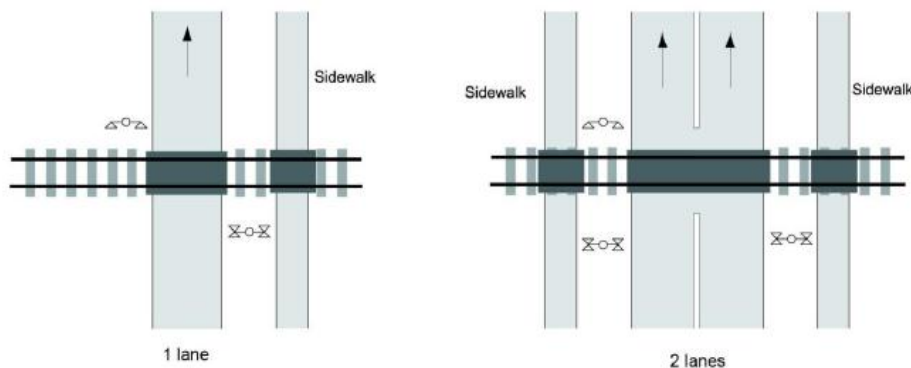

Source: Transport Canada – Grade Crossing Standards

Railway Crossing

- + According to *Transport Canada – Grade Crossings Standards*, if the centreline of a sidewalk/path/trail is greater than 3.6 metres from an existing railway crossing signal head, then a separate pedestrian gate is required.
- + With the extension of the multi-use trail, it can be expected that pedestrian and cyclist activity in the area will increase.
- + It can also be expected some cyclists may use the sidewalk to travel and cross over the railway crossing.
- + Therefore, it is recommended that a 'Detail Safety Assessment for a Railway Crossing' be completed to determine if a separate pedestrian gate would be required.

Parkdale Ave to Brampton St – Long Term



- + Trail runs approximately 550 metres through industrial property
- + Large property acquisition by the City required to extend trail
- + Consider installation of a IPS along the Brampton St crossing (pending new count and pedestrian delay study)
- + Road crossings likely to need optical speed tables

Brampton St to Glow Ave – Long Term



- + Trail extends approximately 500 metres
- + Proposed extension of trail extends along City owned property, the Hamilton Pipeline
- + Installation of optical speed tables recommended for pedestrians and cyclists to continue along the trail

Tate Ave & Glow Ave – Long Term

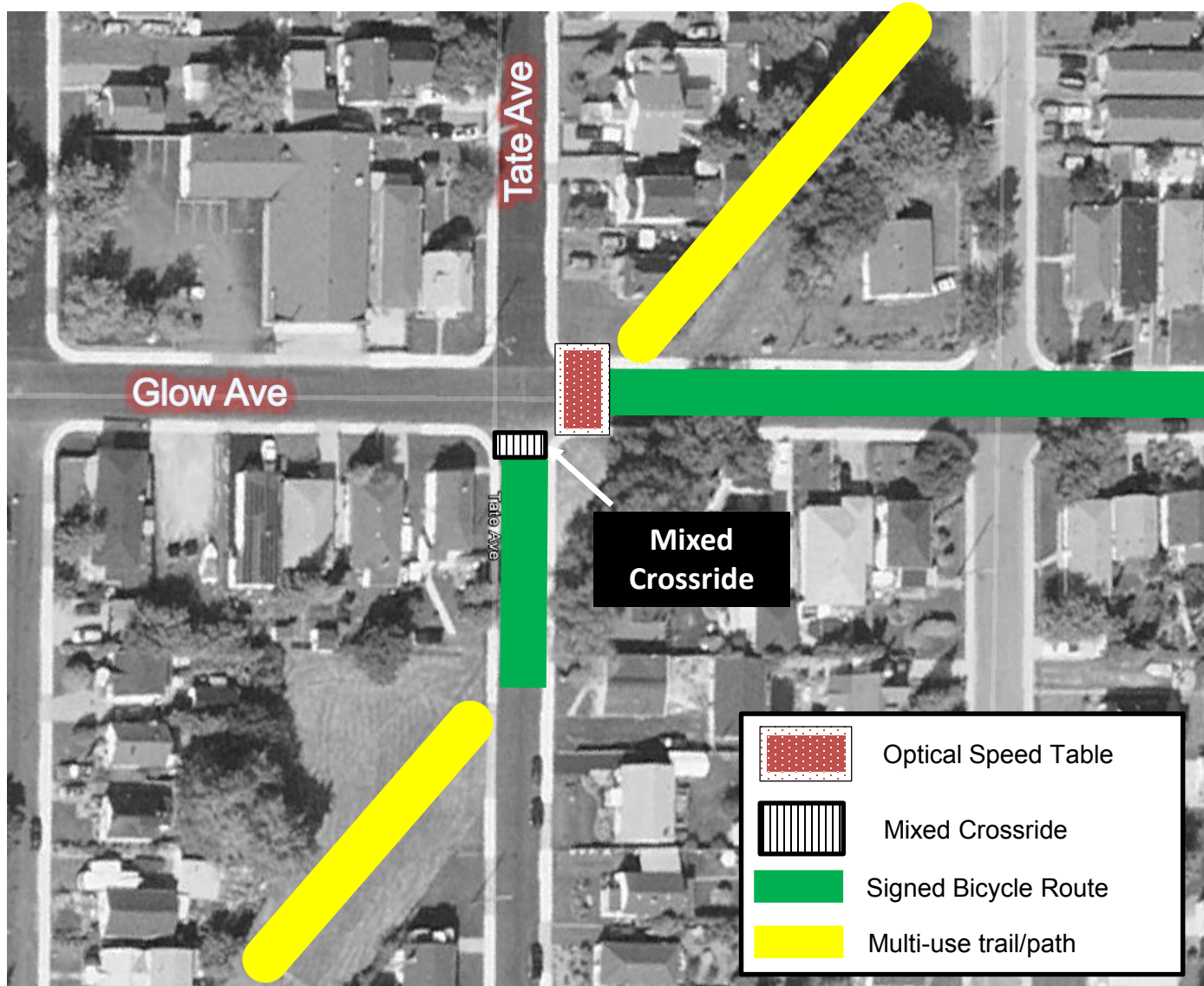

- + Installation of optical speed table recommended along Glow Avenue for pedestrians and cyclists to cross and continue along the trail
- + Tate Ave and Glow Ave to be signed as bicycle routes for cyclists crossing along the trail

Woodward Ave – Long Term

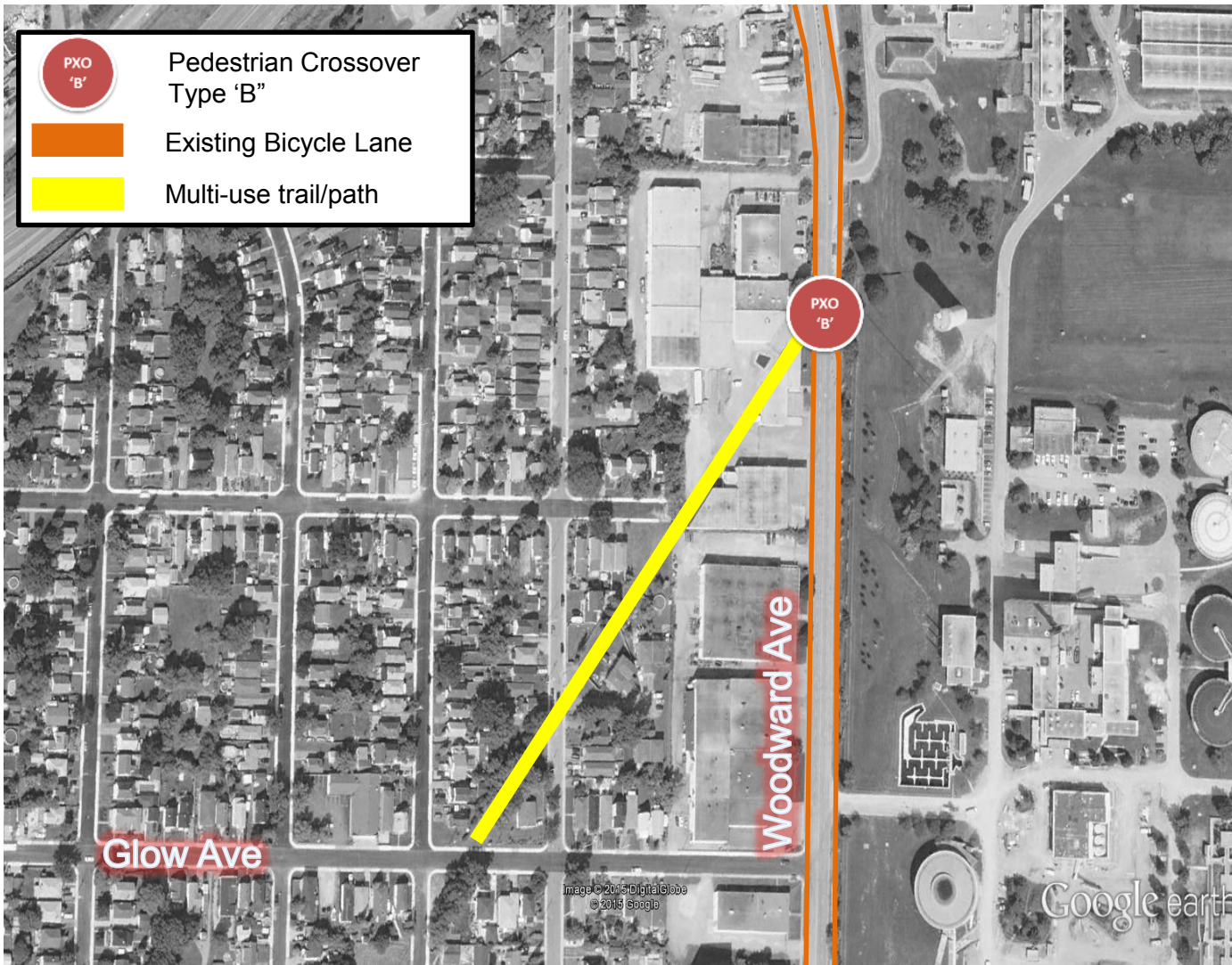

- + Trail runs approximately 340 metres
- + Approximately 130 metres run through industrial property which requires City acquisition
- + Installation of PXO 'B' along Woodward Ave for pedestrians to cross and continue along existing sidewalks
- + Woodward Ave contains existing bike lanes in both northbound and southbound directions for cyclists using the trail
- + Road crossings would likely need optical speed tables

APPENDIX 2

EXP LIGHTING REPORT

499 King Street East, Suite 200
Hamilton, ON L8N 1E1 CANADA
T: 905.525.6069 • www.exp.com



- **City of Hamilton**

Pipeline Trail Master Plan

Lighting Report

Project Number
15014

Prepared By:
Dawn Brown

Date Submitted
May 29, 2015

TABLE OF CONTENTS

1.0 INTRODUCTION..... 1

2.0 LIGHTING OBJECTIVES & CONSIDERATIONS..... 2

3.0 LIGHTING DESIGN ANALYSIS..... 3

3.1 Illumination 3

3.2 Light Pollution 3

3.3 Energy Consumption..... 4

3.4 Order of Magnitude opinions of Probable Electrical Construction Cost 4

4.0 APPENDICES..... 5

4.1 Appendix 'A' - Lighting Fixture Cut Sheets 5

4.2 Appendix 'B' - Lighting Layout Drawings..... 5

1.0 INTRODUCTION

The City of Hamilton's (CoH) Pipeline Trail which runs along the water pipeline easement through Lower Hamilton, in Wards 3 and 4, is a well-used trail that has been identified by the community as having potential for improvement.

The existing trail is constructed from the westerly terminus at London Street North at Main Street, to the easterly terminus at Strathearne Avenue at Barton Street. The City owned easement continues east to the Woodward Water Treatment Plant, through commercial businesses, adjacent to city parkland and through residential areas.

The City wishes to examine future connection potential through these undeveloped portions, as well as making regional trail connections, such as to Gage Park to the west, and to the Red Hill Valley Trails to the east.

To that end, the City has requested that a Master Plan be prepared to guide future development of the Pipeline lands. One of the amenities, among the many that the community has expressed an interest in seeing being implemented along the trail is pathway lighting. This Report will examine various pathway lighting system options for the proposed trail and include opinions of probable construction costs that the City can then use to advance the development of this project.

This report, prepared by **exp** Services Inc., is intended for the exclusive use of the City of Hamilton and O'Connor Mokrycke Consultants (OMC). Neither **exp** Services Inc., the City of Hamilton nor OMC assume any liability for the use of this report, or for the use of any information disclosed in the report, or for damages resulting from the use of this report, by other parties.



2.0 LIGHTING OBJECTIVES & CONSIDERATIONS

The lighting objective of this project is to create a comfortable luminous environment along the Pipeline Trail that promotes a sense of safety & security and compliments the community aesthetic with minimal environmental impact and long term cost.

To succeed in this endeavor high performance, low brightness luminaires that efficiently distribute light directly to the pathway are essential. Due to the close proximity of houses to the path, warm white (2700K – 3000K) light is preferred over cool white (4000K+) light as it is less disruptive to the human sleep/wake cycle. Visibility can be enhanced by using high colour rendering (80+ CRI) LED's. Reducing the contrast between bright-to-dark areas along the path will assist in the detection of danger at a safe distance. Luminaires with a "B-U-G" (Backlight-Uplight-Glare) rating of B=1, U=0, G=1 or lower mounted at approximately 4.6 m (15') above grade and spaced approximately 25 m (80') apart are ideal for eliminating light pollution and creating a comfortable luminous environment. The long term energy and maintenance costs associated with any lighting system can be reduced with a well-planned design. High performance, low wattage luminaires combined with a well thought out pole layout will require less light and allow for lower wattage luminaires. Low wattage luminaires typically last longer because as they run at a cooler operating temperature. Motion activated control sensors also reduce energy consumption and extend the system life by dimming or switching OFF the lights throughout the night; however, if this control option is used and the lighting is reduced below IES recommended levels, the sense of safety and security may be compromised. A well-planned design using high performance, low wattage luminaires is therefore a better strategy for achieving optimal energy consumption and system longevity for this project.

Solar powered lighting uses batteries to power the luminaires during the night and consumes zero utility power. Solar powered lighting does however, require a specific amount of sun exposure in order for the battery to fully charge. Due to climate conditions, some manufacturers may not be able to provide 100% light output from dusk to dawn. Instead, they will dim the fixture by a specific amount for a predetermined length of time. All settings are pre-set in the factory and cannot be changed in the field. For safety reasons, as previously noted for motion activated control, we recommend that, if solar power lighting is to be considered, only manufacturers capable of providing the required light levels from dusk to dawn be considered for this project and that the final locations for solar powered lighting be limited to ones with direct sun exposure throughout the day.

3.0 LIGHTING DESIGN ANALYSIS

3.1 Illumination

Illuminance calculations were performed for three lighting options:

- Option 'A' – High performance AC powered lighting
- Option 'B' – High performance Solar powered lighting
- Option 'C' – Standard performance AC powered lighting

Luminaire cut sheets are provided in Appendix 'A'. To demonstrate the various fixture styles available, Options 'A' and 'B' are represented by matching contemporary style luminaires and Option 'C' is represented by a traditional style luminaire. The illuminance results are summarized in the table below, which demonstrates that with a well-planned layout the IES recommendations¹ for illuminance can be met using any of the three lighting options.

| RECOMMENDED ILLUMINANCE | RECOMMENDED UNIFORMITY RATIO | DESIGN OPTION | DESIGN ILLUMINANCE | DESIGN UNIFORMITY RATIO |
|-------------------------|------------------------------|---------------|--------------------|-------------------------|
| 10 lux Average | 4.0 Average/Minimum | A | 18 lux Average | 3.7 Average/Minimum |
| | | B | 12 lux Average | 4.1 Average/Minimum |
| | | C | 16 lux Average | 3.2 Average/Minimum |

3.2 Light Pollution

The layouts for Options 'A' and 'C' are provided in Appendix 'B'. These layouts illustrate the effect of different luminaire optics (Note that Options 'A' and 'B' are identical in terms of optics) on light pollution. Option 'A' luminaires have a BUG (Backlight-Uplight-Glare) rating of B=1, U=0, G=0 and Option 'C' luminaires have a B-U-G rating of B=1, U=0, G-1, which in both cases is excellent for reducing sky glow and glare. Option 'A' luminaires (with the exception of two) have a long and narrow distribution pattern while Option 'B' luminaires have a wide distribution pattern. By comparing the two layouts it can be seen that, in general, a long and narrow distribution pattern delivers light along the path most efficiently and results in less light trespass.

¹ Recommendations are as per IES/ANSI Roadway Lighting RP-8-14 for walkway lighting in high pedestrian conflict areas.

3.3 Energy Consumption

The amount of utility supplied power required for each option to run from dusk to dawn throughout the year² is noted below.

- Option 'A' – High performance AC powered lighting = 7,154 kWh/year
- Option 'B' – High performance Solar powered lighting = 0 kWh/year
- Option 'C' – Standard performance AC powered lighting = 12,519 kWh/year

3.4 Order of Magnitude opinions of Probable Electrical Construction Cost

Our order of magnitude opinions of probable construction cost³ for each lighting option is as follows:

- Option A – High performance AC powered lighting = \$272,000
- Option B – High performance Solar powered lighting = \$409,000
- Option C – Standard performance AC powered lighting = \$243,000

² Based on 2593 daylight hours per year.

³ Our opinions of cost are based on the lighting fixture selections and layouts provided with this report and include material costs as provided by each manufacturer as well as material and labour costs associated with concrete footings and power circuits. For options 'A' and 'C' cost associated with the provisions of a new hydro service or each segment of trail between streets has been included in the value of \$15,000 per segment. Our opinions of cost are based on a short sample section of proposed trail and then extrapolating the resultant costs to the total trail length represented in the layouts. Please note that we have no control over the cost or availability of labor, equipment or materials, or over market conditions or the Contractor's method of pricing, and that our opinions of probable construction cost are offered on the basis of our professional judgment and experience. We make no warranty, express or implied, that the bids or the negotiated cost of the Work will not vary from our opinions of probable construction cost and should not be construed as a maximum guaranteed price. If more accurate cost estimates are required, an independent cost estimator or certified quantity surveyor should be retained.

4.0 APPENDICES

4.1 Appendix 'A' - Lighting Fixture Cut Sheets

4.2 Appendix 'B' - Lighting Layout Drawings



***Appendix A -
Lighting Fixture Cut Sheets***



SILL® Cityliter™ LED



| | | | | | | | |
|--------------------------|--------------|-----------|---------------|-----------|-----------|------------------------|-----------|
| Project: AS NOTED | | | | | | | |
| Type: AS NOTED | | | | | | Qty: SEE LAYOUT | |
| S454L | R1/R4 | 1 | 4TL350 | 30 | SV | 120 | DS |
| Series | Optics | Mounting | Light Engine | CCT | Finish | Voltage | Options |
| S35 | 16 | SV | PC | | | | |
| Pole Series | Height | Finish | Options | | | | |

| Series | Optics | Mounting | Light Engine | CCT | Finish | Voltage | Options |
|--|--------------------------|----------|-------------------------------|----------|---------------------------------------|---------|--|
| S454L SILL® Cityliter™ LED Arm Mount | R1 Type I Distribution | 1 Single | 4TL350 ¹ 350mA/40w | 30 3000K | WH White | 120 | DS 0° Fixed Position (Full Cutoff) DM ¹ Dimming (0-10v) <small>¹ No Dimming at 350mA</small> |
| | R2 Type II Distribution | 2 Double | 4TL500 500mA/58w | 45 4500K | BK Black | 208 | |
| | R3 Type III Distribution | W Wall / | | | BZ Bronze | 277 | |
| | R4 Type IV Distribution | Ceiling | | | SV Silver SP Specify Premium Color | | |

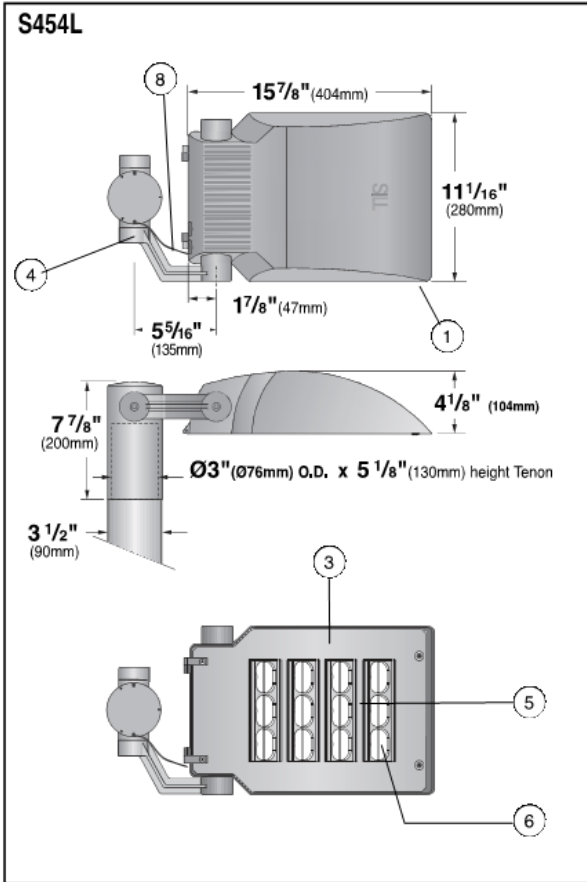

- 1. Fixture Housing** - Die cast low-copper aluminum fixture housing with integral heat dissipating fins.
- 2. Gasketing** - (not shown) Continuous molded silicone gasket provides seal at door opening.
- 3. Access Door** - Steel door, hinged with integral die cast hinges, and secured with captive stainless steel hardware for ease of maintenance.
- 4. Mounting Bracket** - Die cast low-copper aluminum mounting arm, serated to lock luminaire into aimed position. Available in either single or double post mount, as well as wall and ceiling mount configurations.
- 5. LED Light Engine** - High efficacy LED light engine with 60,000 hour life until L70. Available with 3000K or 4500K CCT and a CRI of 80, Protection class IP67.
- 6. Optics** - High transmittance custom molded lenses create IES distribution types I, II, III and IV with IDA-Approved "Dark Sky Friendly" performance.
- 7. LED Driver** - (Not shown) High power factor, High efficiency constant current LED driver. 120-277 VAC input. Protection class IP67.
- 8. Cord** - 18-3 STWA power cord supplied 3 ft. long. Secured to fixture with watertight strain relief. Other cord lengths are available, consult factory.
- 9. Surge Protection** - (Not shown) 3-Pole Surge protection device safeguards electrical components from indirect lighting strikes and surges up to (10kA and 10kV). RoHS compliant.

Exterior Luminaire Finish - Selux utilizes a high quality Polyester Powder Coating. All Selux luminaires and poles are finished in our Tiger Drylac certified facility and undergo a five stage intensive pretreatment process where product is thoroughly cleaned, phosphated and sealed. Selux powder coated products provide excellent salt and humidity resistance as well as ultra violet resistance for color retention. All products are tested in accordance with test specifications for coatings from ASTM and PCI.

Standard exterior colors are White (WH), Black (BK), Bronze (BZ), and Silver (SV). Selux premium colors (SP) are available, please specify from your Selux color selection guide. Hot Dip Galvanized finish (GV) on all steel parts also available.

5 Year Limited LED Luminaire Warranty - Selux offers a 5 Year Limited Warranty to the original purchaser that the Selux LED luminaire shall be free from defects in material and workmanship for up to five (5) years from date of shipment. This limited warranty covers the fixture, LED driver and LED light engine when installed and operated according to Selux instructions. Fixture suitable for ambient temperatures of 35 °C (95 °F). For details and exclusions, see "Selux Terms and Condition of Sale."

Listings & Ratings: IP65 Tested to IESNA LM-79-08 and LM-80 test standards at 25°C ambient temperature. Rated for wet locations.

Selux Corp. © 2012
TEL (845) 834-1400
FAX (845) 834-1401
www.selux.us
S454L-1212-01 (ss-V1.25)

NRTL Listed (i.e. UL, CSA)
Union Made Affiliated
with **IBEW Local 363**



In a continuing effort to offer the best product possible, we reserve the right to change, without notice, specifications or materials that in our opinion will not alter the function of the product. Specification sheets found at www.selux.us are the most recent versions and supercede all other printed or electronic versions.



CITY OF HAMILTON PIPELINE TRAIL
HAMILTON, ONTARIO

TYPE
A

Created: 14.05.2015
Revised:

Sill Cityliter® LED



Pole Information

Refer to A35 and S35 Pole specification sheets for construction details, anchorage information and additional options.

A35 & S35
Round Straight Aluminum
& Round Straight Steel Poles

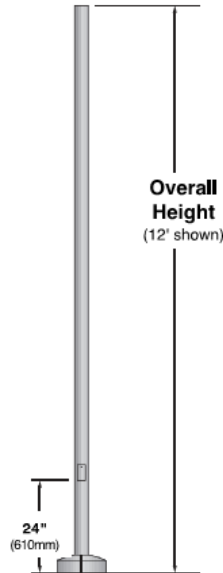

Standard Base Cover (BC5)

Two-piece cast aluminum

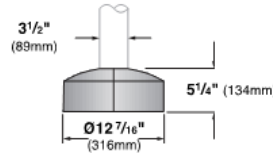

BC1 Optional Base Cover

One-piece cast aluminum

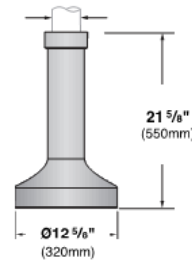

| Pole Series | Bolt Circle | EPA Information (ft ²) | | | | | Height | Finish | Options |
|---|-------------|------------------------------------|--------|--------|---------|---------|--------|--------------------------|---|
| | | 70 mph | 80 mph | 90 mph | 100 mph | 110 mph | | | |
| A35 3 1/2" Dia. Straight Aluminum Pole | 7 3/4" | 16.1 | 12.2 | 9.4 | 7.3 | 5.9 | 8 ft. | WH White | BC1 Die Cast Base Cover |
| S35 3 1/2" Diameter Straight Steel Pole | 7 3/4" | 14.8 | 11.3 | 8.6 | 6.7 | 5.4 | 10 ft. | BK Black | PC Photocell |
| A35 3 1/2" Dia. Straight Aluminum Pole | 7 3/4" | 12.4 | 9.3 | 7.1 | 5.4 | 4.3 | | BZ Bronze | REC GFCI Receptacle with weather-proof cover* |
| S35 3 1/2" Diameter Straight Steel Pole | 7 3/4" | 11.4 | 8.6 | 6.5 | 4.9 | 3.9 | 12 ft. | SV Silver | T3 3" Tennon (included with all poles) |
| A35 3 1/2" Dia. Straight Aluminum Pole | 7 3/4" | 9.9 | 7.3 | 5.4 | 4.0 | 3.1 | | SP Specify Premium Color | * Weatherproof cover intended for portable tools or other portable equipment connected to the outlet only when attended. For other requirements please consult factory. |
| S35 3 1/2" Diameter Straight Steel Pole | 7 3/4" | 9.1 | 6.7 | 4.9 | 3.6 | 2.8 | 14 ft. | | |
| A35 3 1/2" Dia. Straight Aluminum Pole | 7 3/4" | 8.0 | 5.8 | 4.2 | 3.0 | 2.2 | | | |
| S35 3 1/2" Diameter Straight Steel Pole | 7 3/4" | 7.3 | 5.3 | 3.8 | 2.7 | 1.9 | 16 ft. | | |
| A35 3 1/2" Dia. Straight Aluminum Pole | 7 3/4" | 4.9 | 3.2 | 2.2 | 1.4 | 0.8 | | | |
| S35 3 1/2" Diameter Straight Steel Pole | 7 3/4" | 4.4 | 2.8 | 1.9 | 1.2 | 0.6 | 18 ft. | | |
| A35 3 1/2" Dia. Straight Aluminum Pole | 7 3/4" | 3.9 | 2.4 | 1.4 | 0.8 | 0.3 | | | |
| S35 3 1/2" Diameter Straight Steel Pole | 7 3/4" | 3.5 | 2.1 | 1.2 | 0.6 | NA | | | |

Other pole configurations available, consult factory EPA Calculations allow for 1.3 Gust Factor

EPA / Weight of S453-W (with yoke) = 0.48 ft² (0.04m²) / 15 lbs (6.8kg)
EPA / Weight of S454-W (with arm) = 0.56 ft² (0.05m²) / 19 lbs (8.6kg)

EPA / Weight of S454-1 (with arm) = 0.61 ft² (0.06m²) / 19 lbs (8.6kg)
EPA / Weight of S454-2 (with arms) = 1.13 ft² (0.10m²) / 36 lbs (16.3kg)

Selux Corp. © 2012
S454L-1212-04 (ss-V1.25)

In a continuing effort to offer the best product possible, we reserve the right to change, without notice, specifications or materials that in our opinion will not alter the function of the product. Specification sheets found at www.seluxus are the most recent versions and supercede all other printed or electronic versions.



CITY OF HAMILTON PIPELINE TRAIL
HAMILTON, ONTARIO

TYPE
A

Created: 14.05.2015
Revised:



Date: _____ Customer: _____

Project: _____

Type: _____ Qty: _____

SonneLITER LED Solar



Order Code: SDS2LS - R1 - 1 - L30 - 30 - B6 - P4 - 2XXX - PM6 - SV - _____

| | | | | | | | | | | | |
|---------------|--|---|--------------------------------------|---------------------------------------|--|--|--|--|--|--|--|
| <u>SDS2LS</u> | Series | SDS2LS SonneLITER LED Solar | | | | | | | | | |
| <u>R1</u> | Optics | R1 Type I Distribution | R2 Type II Distribution | R3 Type III Distribution | R4 Type IV Distribution | | | | | | |
| <u>1</u> | Mounting | 1 Single | 2 Double | | | | | | | | |
| <u>L30</u> | Light Engine | L20 20W | L30 30W | | | | | | | | |
| <u>30</u> | CCT | 30 3000K | 45 4500K | | | | | | | | |
| * <u>B6</u> | Batteries | B1 One 12V 118 Ah | B2 Two 12V 118 Ah | B3 One 12V 146 Ah | B4 Two 12V 146 Ah | B5 One 12V 176 Ah | B6 Two 12V 176 Ah | | | | |
| * <u>P4</u> | Panel | P1 110W Single | P2 110W Double | P3 140W Single | P4 140W Double | | | | | | |
| * <u>2XXX</u> | Operation Profile <small>(see page 4)</small> | 1 _____ Hours PM Dim % Hours AM | 2 XXX All night 100% | 3 XXX All Night 30% | 4 XXX 4 hours PM 0 hours AM | 5 XXX 6 hours PM 0 hours AM | 6 XXX 8 hours PM 0 hours AM | 7 XXX 2 hours PM 2 hours AM | 8 XXX 4 hours PM 2 hours AM | 9 XXX 6 hours PM 2 hours AM | 10 XX 8 hours PM 2 hours AM |
| * <u>PM6</u> | Panel Mounting Angle | PM0 3° | PM1 15° | PM3 30° | PM4 45° | PM6 60° | | | | | |
| <u>SV</u> | Finish | WH White | BK Black | BZ Bronze | SV Silver | GV Galvanized | SP Specify Premium Color | | | | |
| | Options | MS Motion Sensor | | | | | | | | | |

*To be determined by Selux engineering for every project. For system sizing quote, please complete spec sheet and solar questionnaire (under "Additional Downloads" on Selux.us solar web pages) for submission to selux.technical@selux.com

Pole Order Code: S60 - 16 - SV - BC9
Series Height Finish Options

See pages 8 and 9 for details.

Approvals

Date:



Selux Corporation © 2013, T 845-834-1400, 800-735-8927, F 845-834-1401, www.selux.us

In a continuing effort to offer the best product possible, we reserve the right to change, without notice, specifications or materials that in our opinion will not alter the function of the product. Specification sheets found at www.selux.us are the most recent versions and supercede all other printed or electronic versions.

Page 1 of 9
(Rev. 08/2014)
SDS2LS_ss_v3.0



499 King St. E, Suite 200
Hamilton, ON L8N 1E1
905.525.6069

CITY OF HAMILTON PIPELINE TRAIL
HAMILTON, ONTARIO

TYPE
B

Created: 14.05.2015
Revised:

LED Information

| SonneLITER LED Solar - SDS2LS | | Light Engine | | L30 | L20 |
|-------------------------------|-------------|---------------------------------------|--|-------|-------|
| | | Total Luminaire Power Consumption (W) | | | |
| Lumen Output (lm) | 3000K (CCT) | R1 - Type I | | 1,826 | 1,278 |
| | | R2 - Type II | | 1,793 | 1,255 |
| | | R3 - Type III | | 1,793 | 1,255 |
| | | R4 - Type IV | | 1,793 | 1,255 |
| | 4500K (CCT) | R1 - Type I | | 2,371 | 1,660 |
| | | R2 - Type II | | 2,328 | 1,630 |
| | | R3 - Type III | | 2,328 | 1,630 |
| | | R4 - Type IV | | 2,328 | 1,630 |

| Mounting Height | Multiply |
|-----------------|----------|
| 10' (3.0 m) | 1.27 |
| 12' (3.7 m) | 1.16 |
| 14' (4.3 m) | 1.07 |
| 16' (4.9 m) | 1.00 |
| 18' (5.5 m) | 0.84 |

Operation Profile Options

SO-Bright® Technology

effectively manages the complex balance between key components in an autonomous solar powered LED system. LEDs are driven using a constant-current method which offers high efficiency and precise control of light levels.

SO-Bright® Technology gives you the option to choose from 10 different pre-programmed lighting profiles pictured in the table to the right. Most systems can be programmed for all night illumination at peak level, depending on your power package. The SO-Bright® remote control allows you to change the lighting profile on your system with the push of a button.

Create a (4) digit code to design your own profile. Example:

1
5
3
4
 Profile Hours Dim Hours
 PM % AM

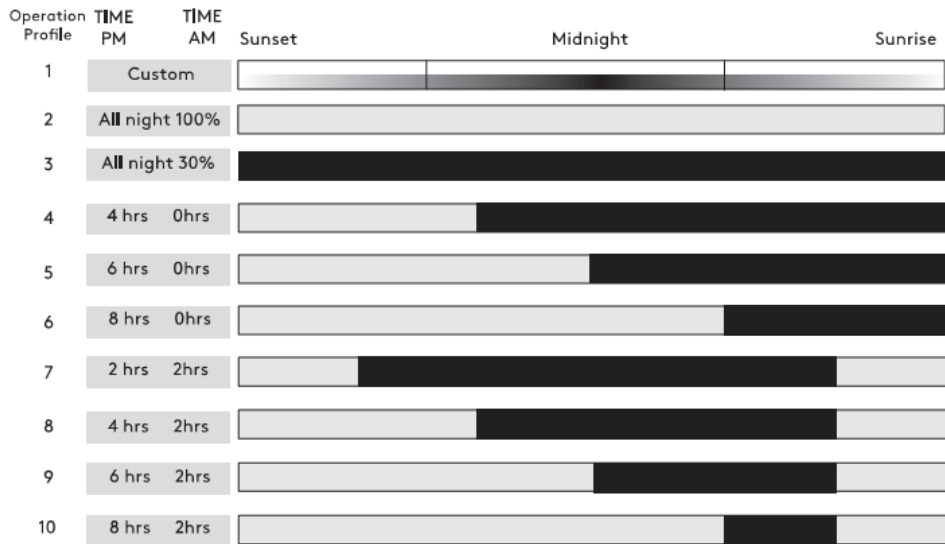

100% On
 30% Dim

- Profiles 3-10 dim to 30% between PM and AM hours by default.
- Profile 1 provides a custom profile. Dim level can be specified with a single number between 1 and 9. (e.g. 2 = 20% LEDs dim to 20% power)



499 King St. E, Suite 200
Hamilton, ON L8N 1E1
905.525.6069

CITY OF HAMILTON PIPELINE TRAIL
HAMILTON, ONTARIO

TYPE
B

Created: 14.05.2015
Revised:

Mounting Details

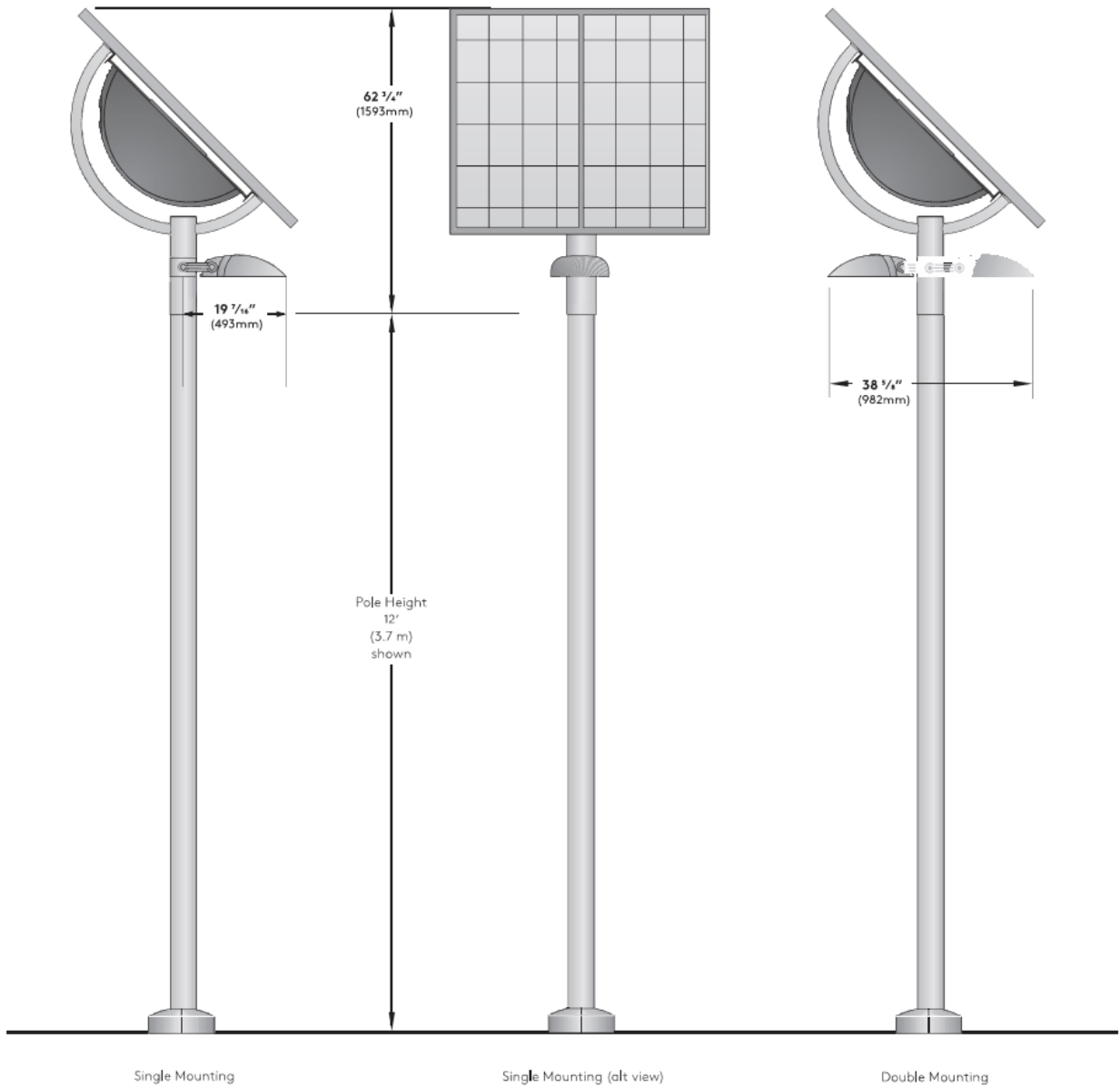

* = Dimension changes based on panel angle and size configurations.
P4 Panel with PM4 (45°) Angle shown. See page 7 for details.

Weight Chart for all Configurations

| Fixture Assembly Weights | | | | | |
|---|----------------|---------|-----|---------|--|
| Panel | Batteries | Weights | | Systems | |
| | | lbs. | kg. | | |
| P1 110W Single Panel (110 Watt) | B1 (1 x 118Ah) | 216 | 98 | | |
| | B2 (2 x 118Ah) | 279 | 127 | | |
| | B3 (1 x 146Ah) | 228 | 103 | | |
| | B4 (2 x 146Ah) | 303 | 137 | | |
| | B5 (1 x 176Ah) | 244 | 111 | | |
| | B6 (2 x 176Ah) | 319 | 145 | | |
| P2 110W Double Panels (220 Watt) | B2 (2 x 118Ah) | 299 | 136 | | |
| | B4 (2 x 146Ah) | 323 | 147 | | |
| | B6 (2 x 176Ah) | 355 | 161 | | |
| P3 140W Single Panel (140 Watt) | B1 (1 x 118Ah) | 223 | 101 | | |
| | B2 (2 x 118Ah) | 286 | 130 | | |
| | B3 (1 x 146Ah) | 235 | 107 | | |
| | B4 (2 x 146Ah) | 310 | 141 | | |
| | B5 (1 x 176Ah) | 251 | 114 | | |
| | B6 (2 x 176Ah) | 342 | 155 | | |
| P4 140W Double Panels (280 Watt) | B2 (2 x 118Ah) | 313 | 142 | | |
| | B4 (2 x 146Ah) | 337 | 153 | | |
| | B6 (2 x 176Ah) | 369 | 167 | | |

Motion Sensor Details

Motion Sensor (MS) option for double head uses two (2) motion sensors to provide 360° coverage as standard.

MS option for single head uses one (1) motion sensor to provide 270° coverage as standard.

Upon sensing motion, luminaire will go from dim level (30% dim standard) to 100% output. System provides a 10 minute delay before returning the luminaire to the dim level (30% dim standard) after activity has ended.

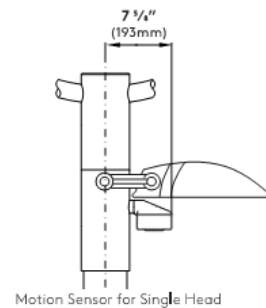
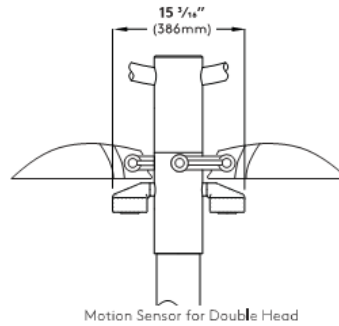

499 King St. E, Suite 200
Hamilton, ON L8N 1E1
905.525.6069

CITY OF HAMILTON PIPELINE TRAIL
HAMILTON, ONTARIO

TYPE
B

Created: 14.05.2015
Revised:

Mounting Option Details

Straight Steel Pole Information

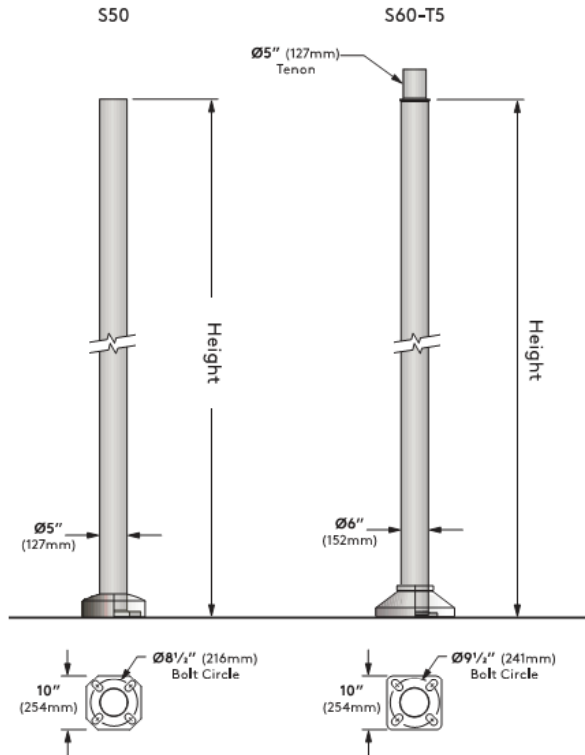

10" x 10" x .75" Base Plate for S50, and a 10" x 10" x 1" Base Plate for S60. Use caution when setting anchor bolts. Bolts must be vertical and centered on dimensions shown. A Ø5" Tenon is required for all poles over Ø5".

Straight Pole Anchor Bolt Detail

See Anchor Bolt (AB) chart below for dimensions.

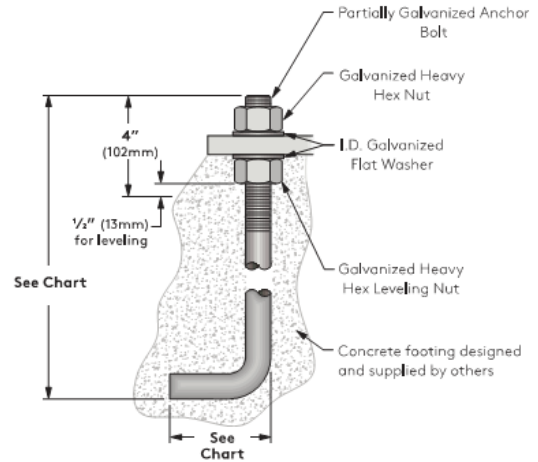

Base Cover Information

Refer to pole specification sheets for construction details, anchorage information and additional options.

BC3 Standard Base Cover for S50 poles

Two-piece die-cast aluminum, field installable base cover.

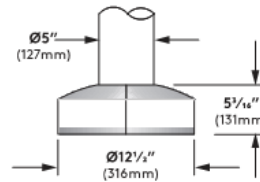

BC9 Standard Base Cover for S60 poles

Two-piece die-cast aluminum, field installable base cover.

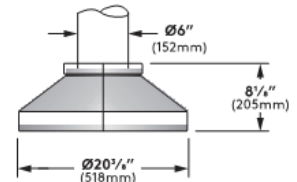

| Pole Series | Bolt Circle | AB Size | EPA Information | | | | | | | Height | Finish | Options |
|---|-------------|------------------|-----------------|--------|--------|--------|--------|--------|--------|-----------|--------------------------|--|
| | | | 90mph | 100mph | 110mph | 120mph | 130mph | 140mph | 150mph | | | |
| S50 5" (127mm) Diameter Straight Steel Pole | Ø8 1/2" | 1" x 36" x 4" | 34.5 | 28 | 23.5 | 19.5 | 16.5 | 14.5 | 12.5 | 10 10 ft. | WH White | BC3 Optional Two-Piece Cast Aluminum Base Cover (for S50 poles only) |
| S50 5" (127mm) Diameter Straight Steel Pole | Ø8 1/2" | 1" x 36" x 4" | 29 | 23.5 | 19.5 | 16.5 | 14 | 12 | 10.5 | 12 12 ft. | BK Black | |
| S60 6" (152mm) Diameter Straight Steel Pole | Ø9 1/2" | 1.25" x 36" x 6" | 60 | 49 | 40.5 | 34.5 | 29 | 25 | 22 | 14 14 ft. | BZ Bronze | BC9 Optional Two-Piece Cast Aluminum Base Cover (for S60 poles only) |
| S50 5" (127mm) Diameter Straight Steel Pole | Ø8 1/2" | 1" x 36" x 4" | 24.5 | 20 | 16.5 | 14 | 11.75 | 10 | 8.75 | | SV Silver | |
| S60 6" (152mm) Diameter Straight Steel Pole | Ø9 1/2" | 1.25" x 42" x 6" | 51 | 42 | 35 | 29.5 | 25 | 21.5 | 19 | 16 16 ft. | GV Galvanized | |
| S50 5" (127mm) Diameter Straight Steel Pole | Ø8 1/2" | 1" x 36" x 4" | 20.75 | 16.5 | 13.75 | 11.5 | 9.75 | 8.25 | 7.25 | | SP Specify Premium Color | |
| S60 6" (152mm) Diameter Straight Steel Pole | Ø9 1/2" | 1.25" x 42" x 6" | 44 | 36 | 30 | 25 | 21.5 | 18.5 | 16 | 18 18 ft. | | |
| S50 5" (127mm) Diameter Straight Steel Pole | Ø8 1/2" | 1" x 36" x 4" | 17.5 | 14 | 11.5 | 9.75 | 8.25 | 7 | 6 | | | |
| S60 6" (152mm) Diameter Straight Steel Pole | Ø9 1/2" | 1.25" x 42" x 6" | 38 | 31 | 26 | 21.5 | 18.5 | 16 | 13.75 | | | |

EPA calculations designed for 3 Second Gust Wind Speeds in mph at 33 ft above ground accordance with the Standard Specifications for Structural Supports for Highway Signs, Luminaires, and Traffic Signals, Fifth Edition, ASSHTO 2009 LTS-5-E

Please consult Selux engineering to determine wind load requirements for your specific project. See chart on p.7 for fixture and panel EPA values.



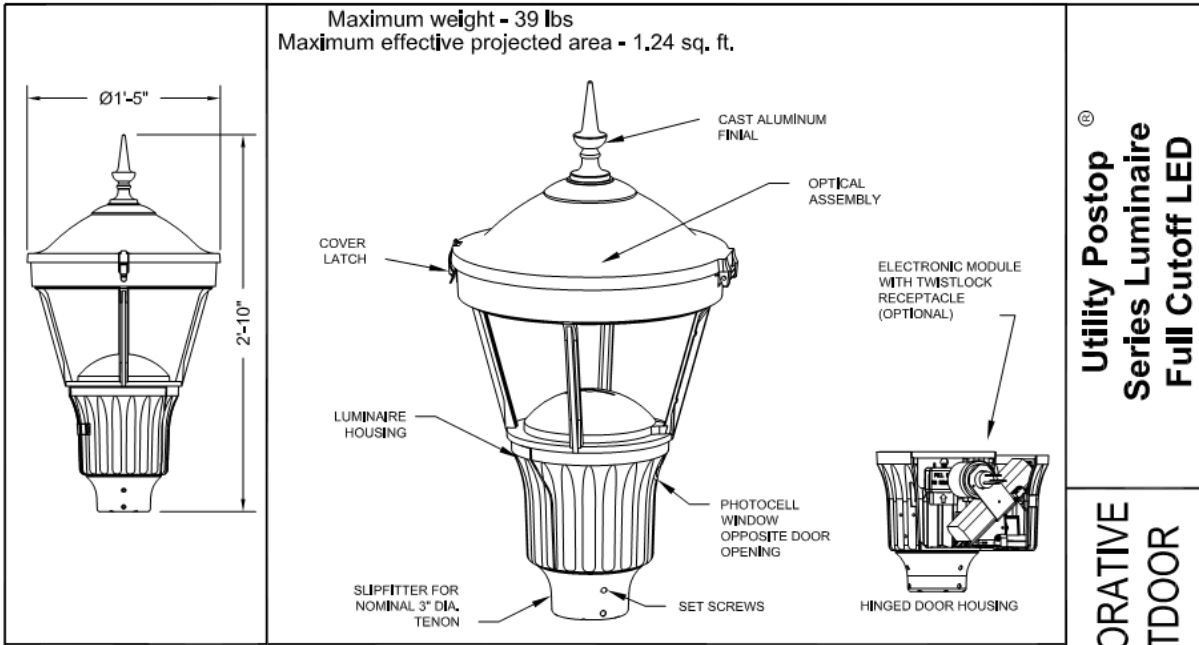

Maximum weight - 39 lbs
Maximum effective projected area - 1.24 sq. ft.

Utility Postop
Series Luminaire
Full Cutoff LED

DECORATIVE
OUTDOOR

HOLOPHANE
An Acuity Brands Company
LEADER IN LIGHTING SOLUTIONS

©2010 ACUITY BRANDS LIGHTING INC.. All Rights Reserved

ORDERING INFORMATION:

EXAMPLE: PUL 070 6K AS B L3 S

| | | | | | | |
|--|------------|---|--|--|--|--|
| PUL | 070 | 3K | AS | B | L3 | S |
| WATTAGE / DRIVER 070 = 70 W (350mA) 105 = 105 W (525mA) | | | VOLTAGE AS = AUTO-SENSING VOLTAGE (120 THRU 277 V) AH = AUTO-SENSING VOLTAGE (347 THRU 480 V) | COLOR A = AS SPECIFIED B = BLACK D = DARK GREEN RAL6005 E = BROWN GREEN RAL6008 F = DARK GREEN RAL6009 H = DARK GREEN RAL6012 N = GREEN W = WHITE Z = BRONZE | OPTICS L3 = ASYMMETRIC FULL CUTOFF, FLAT GLASS L5 = SYMMETRIC FULL CUTOFF, FLAT GLASS | FINIAL (FACTORY INSTALLED) B = BALL S = SPIKE |
| | | COLOR TEMPERATURE 4K = 4000K 3K=3000K 5K = 5000K 6K = 6000K | | | | |

H-PCS

OPTIONS

OPTIONS
DM = 0-10V DIMMING
H = NEMA TWISTLOCK PHOTOCONTROL RECEPTACLE ONLY
L03 = 3 FEET OF PREWIRED LEADS*
L10 = 10 FEET OF PREWIRED LEADS*
L20 = 20 FEET OF PREWIRED LEADS*
L25 = 25 FEET OF PREWIRED LEADS*
L30 = 30 FEET OF PREWIRED LEADS*
PCS = DTL SOLID-STATE LIGHTING PHOTOCONTROL 120-277 VOLT (MUST BE USED WITH OPTION "H")
P34 = DTL TWISTLOCK PHOTOCONTROL 347 VOLT (MUST BE USED WITH OPTION "H")
P48 = DTL TWISTLOCK PHOTOCONTROL 480 VOLT (MUST BE USED WITH OPTION "H")
PSC = SHORTING CAP (MUST BE USED WITH OPTION "H")

*UNIT IS PROVIDED WITH 2 FEET OF PREWIRED LEADS UNLESS OTHERWISE SPECIFIED

ORDER #:
TYPE:
DRAWN: SGK
DATE: 05/04/11
DWG #: LUM_PUL

1 of 2

499 King St. E, Suite 200
Hamilton, ON L8N 1E1
905.525.6069

CITY OF HAMILTON PIPELINE TRAIL
HAMILTON, ONTARIO

TYPE
C

Created: 14.05.2015
Revised:

ROUND TAPERED ALUMINUM POLES



114 Healey Rd.
Bolton, Ontario
L7E 5R2

Phone: (905) 857-8100 Fax: (905) 857-8131

DESCRIPTION:
15'-0" ROUND TAPERED ALUMINUM POLE

DRAWN BY: C. PAGE

CATALOGUE No.:

DATE: MAY / 2015

RTAP15-53B-AB

MATL: ALUMINUM

SCALE: NOT TO SCALE

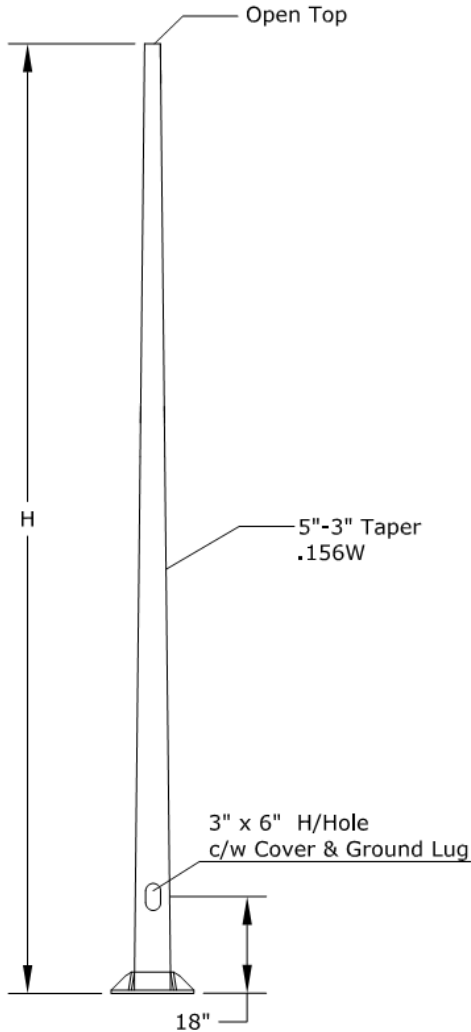

APPLICATION:

For the lighting of streets and highways, parking lots, residential and area lighting.

SPECIFICATIONS:

Round tapered aluminum shaft with elliptical arm(s) detachable for shipping and wiring.

SHAFT:

The shaft shall be fabricated from extruded aluminum alloy 6063 per ASTM B221, B241 or B429. A 3" x 6" hand hole is provided 18" on center above the base plate complete with grounding lug. Hand holes shall have an aluminum extruded frame to maintain structural integrity.

POLE BASE:

The pole base shall be of cast aluminum alloy 356 per ASTM B26 or B108 and be of one piece construction. The base/shaft connection shall have a tight tolerance fit before welding. The shaft shall be joined to the base with two circumferential welds at the top and bottom of the base. The assembly shall be heat treated to a T6 temper after welding to achieve maximum material properties.

ANCHORAGE:

Steel anchor bolts are manufactured to AASHTO specification M314-90, Minimum yield strength 55,000 psi meeting the requirements of ASTM A576. Galvanizing to be per AASHTO M234 Class C - ASTM A153.

WELDING:

All welding is performed by certified welders and conforms to CSA / CWB W47.1 - 47.2

FINISHING:

Poles are Rotary polished & or Phosphate washed, Prime coated, then Powder coated with required color.

GROUNDING:

All poles shall be provided with provisions for grounding.

PACKAGING:

All poles shall be spirally wrapped with protective kink kraft paper. If outdoor storage or storage in moist areas is anticipated, the wrapping should be removed to prevent water marking and staining. The poles shall not be allowed to rest directly on the ground. Do not cover the poles with tarpaulin or similar cover. Additional packaging may be provided depending on the shipping method. Small parts shall be packaged in boxes.

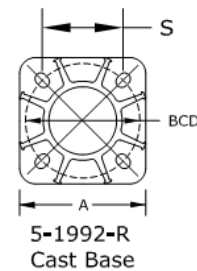

NOTE: 29- Units Required
PROJECT: City of Hamilton Pipeline Trail
FINISH: Powder Coat Black

| SHAFT SIZE | | | DIRECT BURIAL | BRACKET SIZE | | | ANCHOR BASE DETAIL | | | |
|------------|-------|------|---------------|--------------|-------|------|--------------------|--------|-----|---------|
| HEIGHT | TAPER | WALL | | LENGTH | TAPER | WALL | A | BCD | S | A/BOLTS |
| H | | | H | C | | | | | | |
| FEET | IN. | IN. | FEET | FEET | IN. | IN. | IN. | IN. | IN. | IN. |
| 15 | 5-3 | .156 | N/A | N/A | N/A | N/A | 9.75 | 7.5-10 | 6.5 | |



CITY OF HAMILTON PIPELINE TRAIL
HAMILTON, ONTARIO

TYPE
C

Created: 14.05.2015
Revised:

***Appendix B -
Lighting Layout Drawings***



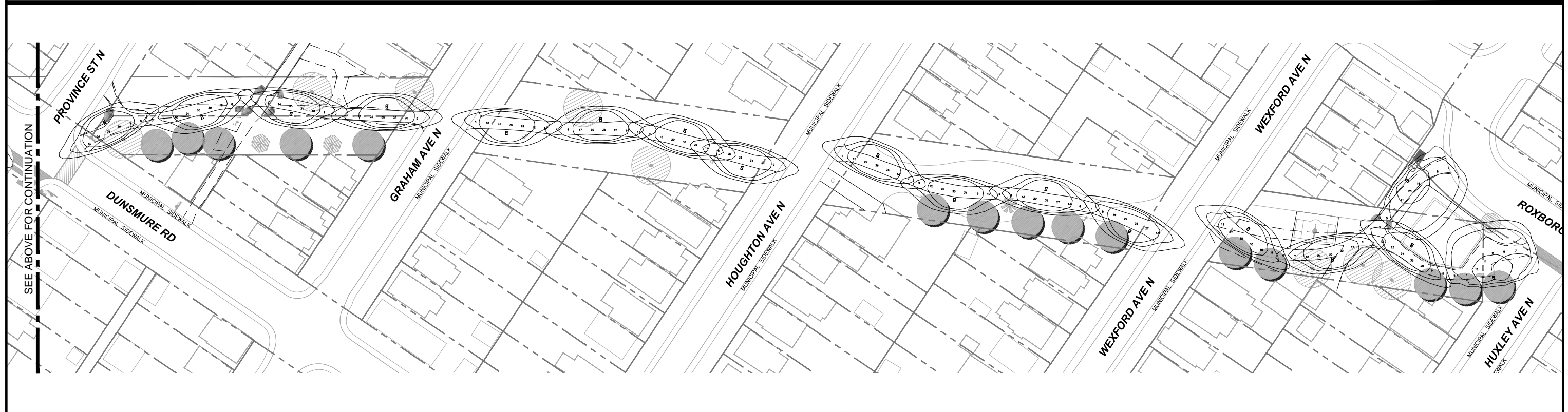

| | | | |
|------|--|---|---------------------------|
| Seal | exp Services Inc. t: 905.525.6069 f: 905.528.7310 499 King Street East, Suite 200 Hamilton, ON L8N 1E1 Canada www.exp.com |  | Project Number : 15014 |
| | Project Title : CITY OF HAMILTON PIPELINE TRAIL | Date : 2015-05-28 | Drawn by : DB |
| | Drawing Title : LIGHTING LAYOUT OPTION 'A' | Drawing Number : E1 | Rev. E1 |

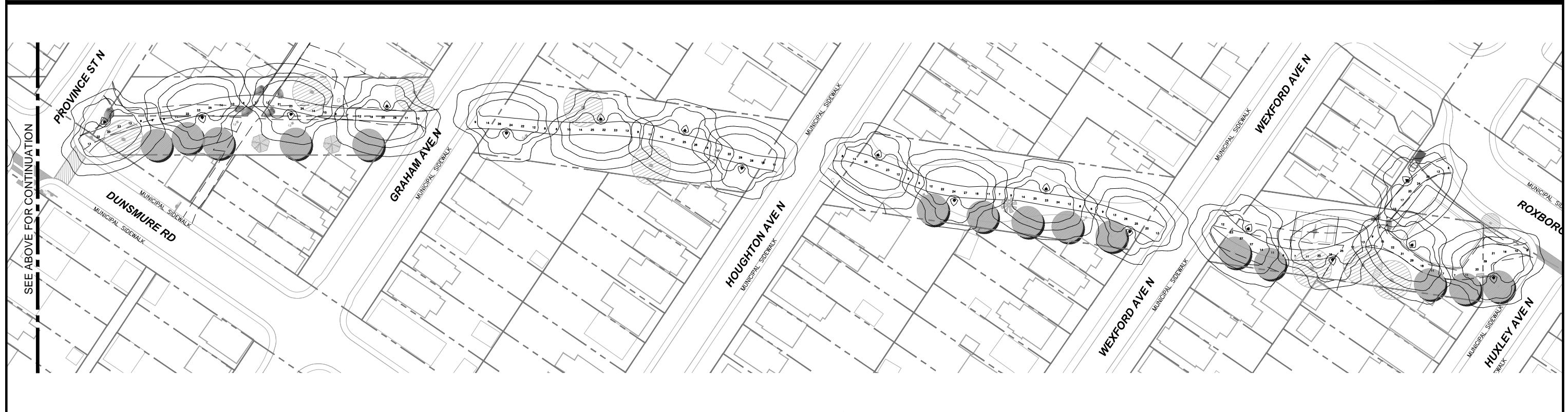
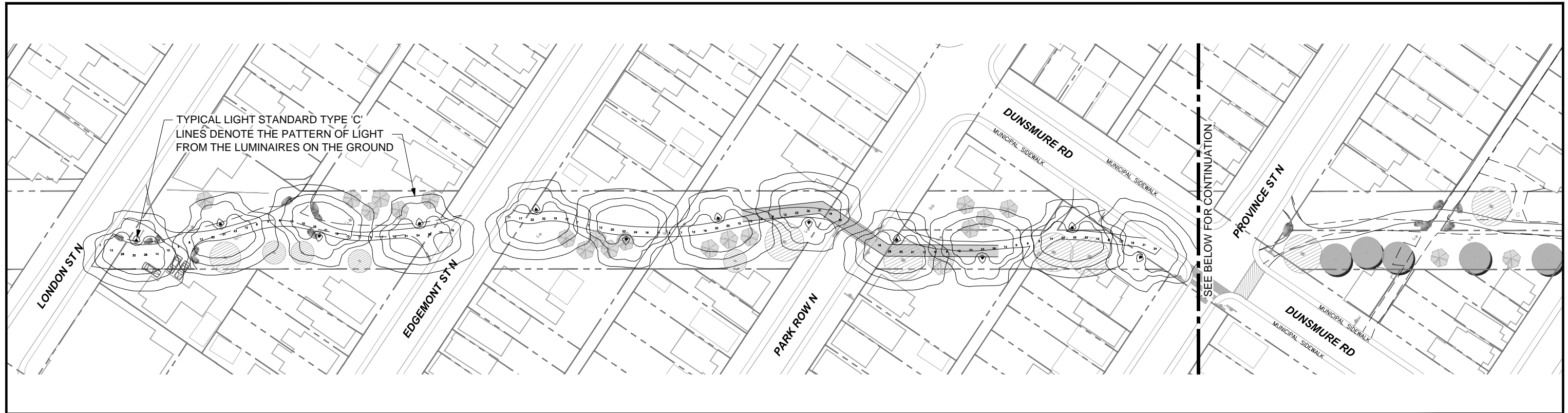

| | | | |
|------|--|---|---------------------------|
| Seal | exp Services Inc. t: 905.525.6069 f: 905.528.7310 499 King Street East, Suite 200 Hamilton, ON L8N 1E1 Canada www.exp.com |  | Project Number : 15014 |
| | Project Title : CITY OF HAMILTON PIPELINE TRAIL | Date : 2015-05-28 | Drawn by : DB |
| | Drawing Title : LIGHTING LAYOUT OPTION 'C' | Drawing Number : E2 | Rev. E2 |

APPENDIX 3

PRECEDENT PROJECTS

PRECEDENT PROJECTS:

A) The Canadian Pacific Railway Pedestrian Bridge

Milton, Ontario

As part of the Master Planning process, community members requested an investigation into elevated pedestrian walkways over railway tracks in two locations near the Pipeline Trail. The two locations were:

- a) the Escarpment Rail Trail connection near the intersection of Lawrence Road and Ottawa Street South.
- b) the rail crossing on Parkdale Avenue between Mahony Avenue and Brampton Street.

The Canadian Pacific Railway Pedestrian Bridge in Milton was reviewed as a precedent project for the following reasons:

- i) it is a current example, having been completed in August 2013, consequently the construction cost will be relevant. The construction cost for the bridge was estimated to be \$2.5 million, with a completed cost of approximately \$3.5 million.
- ii) the bridge is located on an urban multi-use trail, connects two neighbourhoods, and provides improved access to a number of destinations in the Town .
- iii) should community members wish to visit the site it is within driving distance.
- iv) it includes accessible pedestrian circulation (in the form of ramps) and met current accessibility requirements at the time it was designed.

The bridge consists of stairs, elevated walkways and ramps for all bridge users. It is constructed of metal with glass side panels where the bridge spans the CPR tracks. During the winter months the ramps, stairs, and walkways are shovelled by hand. This method of snow clearing is more costly than mechanical snow removal.

O'Connor Mokrycke Consultants (OMC) obtained schematic drawings of the bridge from Town of Milton staff and overlaid them in the areas under review at Parkdale Avenue and at Lawrence and Ottawa Streets. In both cases, it appeared that there was not sufficient ground space to accommodate a bridge of this nature.

At the public meeting of June 25, 2015, there were mixed reactions from the community with respect to the proposed crossings – some people felt that the crossings would be worth implementing, while others felt that the cost and spatial limitations precluded them as desirable options.



Pipeline Trail Master Plan

The Parkdale Avenue crossing has warning signals and gates for vehicles. The crossing near Lawrence Road and Ottawa Street South does not. Some community comments included the desire for a simple grade level crossing across the tracks at the Escarpment Trail connection with safety improvements such as warning signals and gates.

All options will require detailed investigation with full examination of alternatives and exploration of such issues as cost, safety, and regulations.

Other municipal documents such as the Hamilton Recreational Trails Master Plan and the Cycling Master Plan have relevance with respect to this crossing.



Figure A - View of bridge entrance with accessible ramps and rest stop at base, OMC Photo



Figure B -View of track crossing – glass panels. Remaining pedestrian circulation areas indicate railings, OMC Photo

Reference:

https://www.milton.ca/en/play/cp_railwaypedestrianbridge.asp



B) Urban Trail Examples

The following urban trails were reviewed as precedent projects. They provided a rich source of ideas and inspiration for the Pipeline Trail. Excellent concepts and ideas relating to connectivity, sustainability, public art, education and wayfinding were among the ideas found in these examples.

When considering urban trail precedents it must be understood that most funding contributions are based on public and private partnerships. The Pipeline Trail will be redeveloped, constructed and maintained with municipal funding with the exceptions of the community gardens that are being designed, installed and maintained by community volunteers. Future grants from other public or private sources may be available.

1) Downtown Heritage Trail, Washington, DC
<http://www.culturaltourismdc.org>

2) Emerald Necklace Trail, Boston, MA
<http://www.emeraldnecklace.org>

3) Freedom Trail Boston, MA
<http://www.thefreedomtrail.org>

4) Indianapolis Cultural Trail
<http://indyculturaltrail.org>

5) High Line, New York City
<http://www.thehighline.org>

6) Philadelphia Public Art Project
<http://www.planphilly.com/eyes on the street>

What can be learned from these precedent projects is that every community has its own unique qualities and it is essential that these qualities be used to celebrate what is relevant to that community, within its available funding framework.



APPENDIX 4

FUTURE CONSIDERATIONS

FUTURE CONSIDERATIONS:

The following features were not included in the scope of the Pipeline Trail Master Plan. Further investigations are required including consultation with staff and the community, should they wish to be implemented in the future.

Emergency Call Boxes

The call boxes would be similar to those found on post-secondary campuses. For example, McMaster University's criteria for location of call boxes is based on the premise that anywhere on campus, a person should be able to see two emergency telephones. They also locate them in areas of high pedestrian traffic.

Some preliminary locations for consideration along the trail include:

- Between Province Street and Graham Avenue, at the alley intersection
- Andrew Warburton Park
- Between Fairfield and Paling Avenue at the alley intersection
- At Mahoney Park
- Brampton Street at Burgess Avenue
- At rest stop intersection of Tate and Glow Avenue, southeast side
- Leaside Park

These locations are based on a generalized spacing of call boxes throughout the trail in order to establish a preliminary budget.

Should emergency call boxes be desired in future, a detailed review of the Pipeline Trail would be required. It is recommended that the Hamilton Police Service, City of Hamilton staff, and the community be consulted at that time.



Alley Connections

Throughout the Pipeline Trail area, there are many locations where alleys intersect the Trail. There has been recent interest expressed by residents of downtown neighbourhoods toward alley improvements and many have participated in clean up and monitoring activities on a voluntary basis.

The following is a list of streets where public rear alley connections might be achieved: London Street North, Edgemont Street North, Park Row North, Province Street North, Crosthwaite Avenue North, Garside Avenue North, Cameron Avenue North (west side), Tragina Avenue North, Weir Street North, Fairfield Avenue North, Paling Avenue, Strathearne Avenue North (west side)

Please refer to the Map of Pipeline Trail Alleyways.

The study of alleys and their relationship to the Pipeline Trail was not included in the scope of this Master Plan. Further examination will be required to determine the suitability of alleys as urban trail segments and their relationship to the Pipeline Trail.



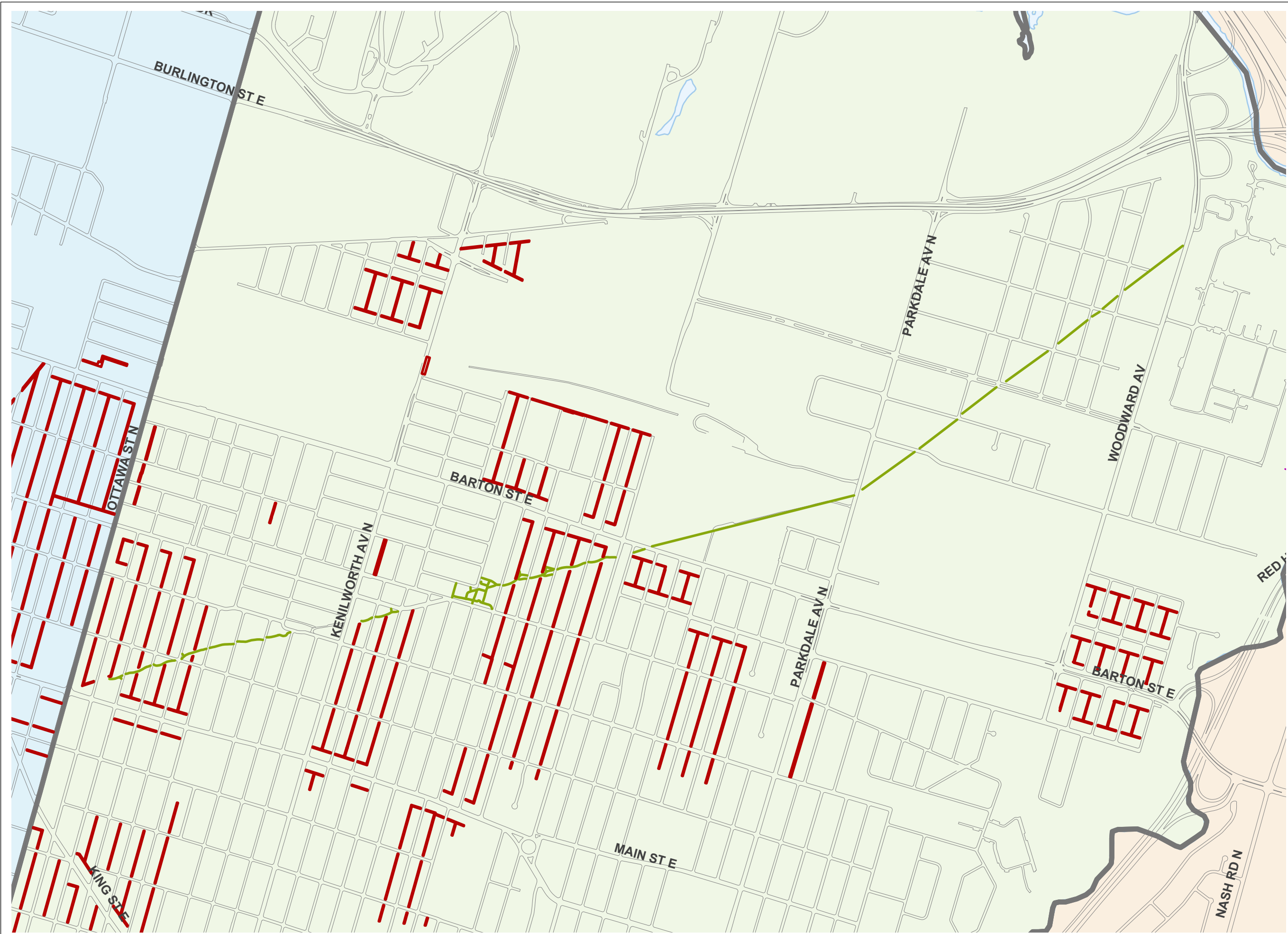

Pipeline Trail 
 Alleyways 

Pipeline Trail
 Alleyways

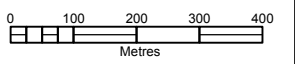

Landscape
Architectural
 services

DATE: October 7, 2015

DRAWN BY: JJ

FILE NAME:

NOTE: